

Advancing adaptive facades for a sustainable future in building design

Batool Mowafaq Kadhimi^{1*}, Abdulla S. AL Maamory², Ahmed M. AL Ghaban³

^{1,2}University of Technology, Architectural Engineering, Iraq; ae.19.33@grad.uotechnology.edu.iq (B.M.K.).

³University of Technology President, Iraq.

Abstract: The essential need to mitigate carbon emissions has brought the energy performance of the building sector into focus. Conventional static façades, which are unable to adapt to dynamic external conditions, often compromise energy efficiency and occupant comfort. In contrast, adaptive façades present a groundbreaking opportunity to transform building design by responding dynamically to environmental stimuli, optimizing energy consumption, and enhancing indoor conditions. This paper explores the recent advancements in adaptive façade systems, emphasizing their potential to improve thermal comfort, daylight performance, and most essential the energy efficiency. In addition, this paper highlights the transformative role of quantum energy and smart materials in advancing façade performance and sustainable design. Overall, this paper underscores the potential of using adaptive façades to transform sustainable building practices, offering architects, researchers, and designers a roadmap for integrating innovative and energy-efficient solutions into the built environment.

Keywords: *Adaptive façades, Kinetic energy, Quantum energy, Sustainability.*

1. Introduction

The global utilization on fossil fuels for energy generation has significantly harmed the environment, driven by rapid population growth and technological advancements [1, 2]. This overuse of fossil fuels has accelerated carbon dioxide (CO₂) emissions, contributing to climate change and its associated effects, such as rising global temperatures, sea level increases, glacier melting, and more frequent extreme weather events [3, 4]. Therefore, enhancing energy efficiency and minimizing CO₂ emissions are critical steps toward achieving a sustainable future for humanity [5]. Consequently, governments have enacted laws and policies that aim to curb emissions and transition to low-carbon energy, promoting sustainable development. The building and construction sector, responsible for a substantial portion of global energy consumption and CO₂ emissions, is a key area where sustainability strategies must be integrated [6, 7]. In particular, in recent years, the building sector has been responsible for 40% of global energy consumption, significantly contributing to greenhouse gas (GHG) emissions [8]. Furthermore, it has been stated that buildings account for approximately 39% of global CO₂ emissions and 50% of raw material extraction, highlighting the critical role energy consumption plays in both construction and operational phases [8, 9]. Besides, buildings represent a substantial share of global energy use, contributing approximately 32% to final energy consumption, 51% to electricity demand, and 33% to carbon emissions [10, 11, 12, 5]. Given the planet's finite resources and the ongoing effects of climate change, addressing the environmental impacts of the building industry becomes essential. This calls for concerted efforts to reduce energy consumption and conserve dwindling natural resources. To this end, developing a sustainable building design represents a key approach in contemporary architecture, focusing on minimizing environmental impact and enhancing energy efficiency and occupant comfort. As such, designing energy-efficient facades

presents a compelling approach to lowering the energy required for maintaining indoor thermal comfort [5]. Modern architecture increasingly emphasizes sustainability, with energy-efficient building facades playing a critical role in reducing energy consumption and enhancing overall environmental performance.

However, building facade systems face significant challenges due to the inherent limitations of conventional materials and technologies. One of the primary obstacles is the lack of adaptability in traditional facade materials. Standard building facades, often made from static materials like glass, concrete, and steel, are designed primarily for durability and aesthetic appeal, rather than energy optimization. These materials offer limited capacity to respond dynamically to environmental conditions, such as temperature fluctuations, light levels, and weather changes, resulting in an inconsistent indoor environment that typically requires additional heating, cooling, and lighting. This reliance on external systems to maintain comfort not only consumes significant energy but also increases operational costs, reducing the building's overall efficiency. Another key issue is the thermal inefficiency associated with traditional materials. While some advancements, such as double glazing and thermal insulation, have been made, these solutions are often insufficient for achieving optimal thermal regulation, especially in extreme climates. The inability of these materials to effectively insulate during winter or cool during summer requires substantial energy expenditure for climate control, undermining the sustainability goals of modern architecture.

Therefore, the lack of flexibility in traditional facade designs restricts their compatibility with emerging smart technologies [13, 14]. Besides, the limitations of traditional materials and the current need for energy-efficient technologies create notable barriers to sustainable design. Overcoming these challenges requires innovative materials and adaptive systems that can seamlessly respond to external conditions and integrate with smart building technologies, paving the way for facades that are not only efficient but also intelligently adaptive. To this end, adaptive facades also known as dynamic facades in architecture is introduced as a key solution to achieve sustainable design [15]. Adaptive facades have the potential to revolutionize building design and user experience. In adaptive facades, sustainability involves incorporating responsive systems that naturally adjust to changes in the environment, thereby reducing reliance on artificial energy. By adjusting to shifting environmental conditions, adaptive facades can substantially lower energy usage and reduce CO₂ emissions, all while improving comfort for those within the building. Committing to adaptive facades technology reflects a dedication to sustainability, offering the construction industry a chance to lead the way toward a built environment that is more energy-efficient, durable, and focused on occupant well-being [15]. Adaptive facades represent a transformative approach in architecture, designed to respond dynamically to environmental changes to optimize a building's energy performance. Unlike traditional, static facades, adaptive systems incorporate materials and technologies that adjust to factors such as sunlight, temperature, and air quality. This adaptability enables facades to regulate heat gain, daylight entry, and ventilation, enhancing indoor comfort while significantly reducing reliance on energy-intensive climate control systems. In the context of sustainable design, adaptive facades play a pivotal role by minimizing energy consumption and lowering greenhouse gas emissions. By integrating intelligent responses to external conditions, adaptive facades contribute to the creation of buildings that are not only energy-efficient but also resilient and environmentally conscious, supporting a shift towards more sustainable urban development. Therefore, advancing adaptive facades represents a significant step toward sustainability, offering the construction industry an opportunity to create buildings that are energy-efficient, resilient, and centered on occupant needs.

The use of quantum energy in adaptive facades could offer an innovative pathway toward sustainable architecture [16, 17]. This could enable facades to respond intelligently to environmental changes, optimizing thermal regulation and natural lighting while reducing reliance on artificial systems. By harnessing quantum-level interactions, materials can dynamically adapt to variations in light, temperature, and weather, fostering energy efficiency and environmental

responsiveness. Integrating quantum physics into architectural design revolutionizes sustainability by introducing advanced materials that enhance functionality and reduce energy consumption. This approach aligns facades with sustainable goals by enabling real-time adjustments in light transmission, heat absorption, and ventilation, contributing to lower CO₂ emissions and resilient structures. By merging architectural innovation with quantum science, this vision promotes eco-conscious, self-regulating building systems that support sustainable urban development.

1.1. Paper Contribution

This paper shifts the focus from conventional studies on static facades to adaptive facades. This paper aims to find methods that allow facades to respond dynamically to changes in the environment. Unlike existing works, our paper addresses critical aspects that have not been thoroughly explored in previous research. Besides, this paper evaluates the energy efficiency and provides a techno-economic assessment of current adaptive facade systems. Moreover, the paper offers valuable insights into how adaptive facade systems can foster healthier, more comfortable living environments while addressing the challenges of modern building practices. We also investigate quantum potential energy and its application in adaptive facade systems. The paper in particular highlights the role of kinetic energy in creating adaptive architectural designs. We also present feasible solutions that enhance energy efficiency and significantly reduce energy consumption. These solutions are critically important in today's world, where optimizing energy use is not only a priority but an essential requirement for sustainable development. In addition, this paper outlines promising directions for future investigations, offering valuable insights that extend beyond the current state-of-the-art literature. This paper serves as a valuable resource for designers and academic researchers and highlights potential avenues for future research.

1.2. Paper Organization

The structure of this paper is organized as follows. Section 2 presents the basic concept of quantum energy and the related terminologies. Section 3 provides details explanation about the adaptive facade in architecture design. Section 4 discussed several case studies and already implemented designs with adaptive facade. Section 5 highlights the advancements and benefits of integrating the quantum energy with adaptive facade. Finally, this paper is concluded in Section 6.

2. Fundamental Principles of Quantum Potential Energy

This section discusses the quantum concept and related terminologies. Architects can develop more sustainable, responsive buildings that align with environmental needs, pushing architectural systems closer to intelligent structures. With quantum potential energy, architects can develop innovation solutions that merge physics with design, creating structures that are environmentally sustainable. This synergy between quantum science and architecture has the ability to exemplify the potential for interdisciplinary approaches to revolutionize building design, ensuring comfort, efficiency, and reduced environmental impact.

2.1. Overview of Quantum Potential Energy

The word quantum can be defined as a physical term used to describe any amount of energy that can be exchanged between particles [18]. In particular, quantum is used to refer to specific amounts of energy that are emitted intermittently, not continuously. The terms quantum physics are often used (quantique physique) and quantum theory (quantum theorie) as synonyms for quantum mechanics [19]. The term "quantum mechanics" pertains to the study of the behavior and properties of quanta. Nature often operates in discrete bursts, or quanta, and quantum mechanics focuses on observing and analyzing this phenomenon. The foundation of quantum theory was laid in 1900 when Max Planck introduced the concept that electromagnetic radiation is emitted in discrete packets, or quanta, which are now referred to as photons [20, 21, 22]. Quantum mechanics

is the branch of physics that explores how matter and energy behave at atomic and subatomic scales, emphasizing the processes of energy absorption and emission by matter rather than just the motion of quanta [23, 19]. Quantum mechanics is important in construction [24].

Quantum potential energy, a concept derived from quantum mechanics, offers a unique perspective on energy dynamics by integrating particle and wave behaviors. Quantum potential energy, derived from the foundations of the de Broglie-Bohm interpretation [25]. Rooted in the de Broglie-Bohm interpretation, this principle highlights the role of virtual photons—oscillating electromagnetic fields—that interact with charged particles to influence their motion. Specifically, the quantum potential can be understood as energy arising from the oscillations of electromagnetic fields, referred to as virtual photons, which interact with charged particles. This interaction offers valuable insights into the dynamics and behavior of particles [26]. This would highlight the influence of virtual photons within quantum systems, portraying quantum potential as a tangible factor that actively governs particle dynamics rather than being a purely mathematical abstraction. Unlike classical potential energy, quantum potential energy is not directly observable but manifests through its effects on particle trajectories, emphasizing the interplay between energy, matter, and wave functions. This framework provides a deeper understanding of energy at the quantum level, transcending classical mechanics.

In architectural innovation, quantum potential energy can serve as inspiration for designing adaptive and energy-efficient structures. For instance, the integration of quantum-inspired materials and technologies allows buildings to dynamically respond to environmental stimuli. Noting that environmental stimuli refer to external factors or conditions in the surroundings that encourage a reaction in systems, or materials [27]. These stimuli can include variations in temperature, light, humidity, wind, sound, pressure, or chemical composition. In architectural and material science, environmental stimuli could encompass temperature changes that influence thermal behavior, sunlight or solar radiation, which affects heat and light management, moisture or humidity levels, impacting material functionality, wind or air pressure, altering structural performance. Therefore, adaptive facades and smart materials are designed to respond to these stimuli, enabling efficient temperature regulation, light control, and energy conservation, much like natural systems adapt to their environment [28, 27].

Adaptive systems leveraging quantum potential are shaped by the interaction between classical dynamics and quantum-like behaviors, particularly within complex adaptive frameworks. This integration unveils how classical systems can exhibit emergent quantum-like properties, fostering adaptability and stability across various applications. The "mock" quantum theory concept demonstrates how classical systems, such as the Lotka-Volterra model, can be expressed using a Schrodinger-type equation [29, 30, 31]. Specifically, the author in [31] started with the conventional formulation of a classical system described by the Hamilton–Jacobi (HJ) equation and transform it into an effective Schrodinger-like equation, incorporating a system-dependent "mock" Planck constant. This transformation requires that the quantum potential termed as VQ , which depends on the state, is neutralized by an additional term within the HJ equation. This additional term is interpreted as representing the interaction between the classical system and its surrounding "environment." In addition, the author in [31] demonstrated that a classical system can effectively nullify the VQ term, at least approximately, through precise adaptation to environmental conditions. By coupling the environment to the system, the state-dependent quantum potential can be neutralized, resulting in stable states [31]. This approach suggests that non-equilibrium dynamics in classical systems can mimic quantum mechanics, offering insights into adaptability observed in biological processes [32]. This is very essential observation that can be beneficial to architecture designers. The conclusion highlights the significance of the state-dependent nature of the mock quantum dynamics. This dependency implies that the system's behavior evolves in response to its current state, which is a critical aspect for comprehending the mechanisms underlying complex adaptive systems.

The state-dependent nature of mock quantum dynamics aligns with this concept, as it demonstrates how systems adapt and evolve based on their current state and environmental interactions [33]. This connection underscores the potential for classical systems, through fine-tuning and interaction with their surroundings, to exhibit behaviors analogous to self-organization observed in quantum contexts. Unlike classical physics, which describes a predictable and continuous universe, quantum mechanics reveals a world where particles can exist in multiple states simultaneously and are influenced by probabilities. Within this framework, quantum potential energy is a concept that describes the energy inherent in quantum systems due to their probability distributions, rather than from physical interactions alone.

Building on the principles of quantum physics, the particles on Earth's surface are subject to the influence of waves emitted by both humans and the universe. These waves continuously interact, subtly affecting and shifting the energy frequencies of individuals and the spaces they inhabit. This creates an intricate feedback loop, where the user and their environment become interconnected, forming an extension of a unified energy source. As energy flows between the internal and external reflections, it influences the physical and mental states of the individual, harmonizing their performance with the energy of the space. This mutual exchange promotes a stable, balanced environment that enhances both the space and the person within it. In this process, there is a natural progression towards a heightened awareness—an intuitive understanding of the fundamental energy that shapes and defines both the individual and the space they occupy. Ultimately, this conscious connection between energy, space, and user fosters a deeper sense of purpose and presence.

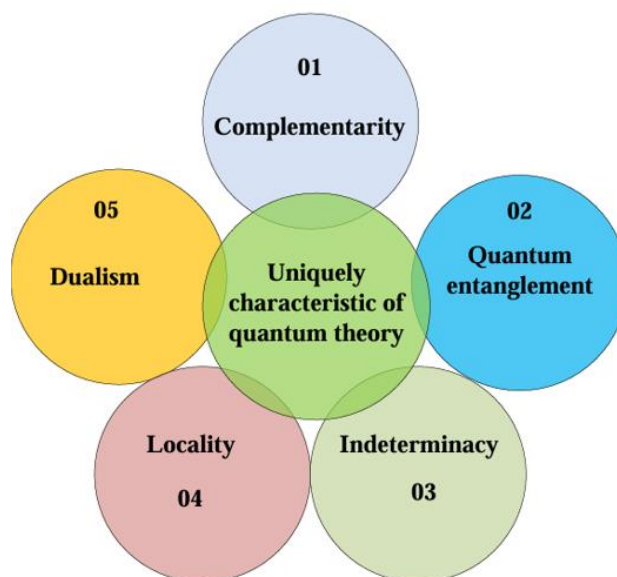

Figure 1.
Lists of uniquely characteristic of quantum theory.

Quantum mechanics has introduced transformative concepts in various fields, including material science and energy systems. A fundamental principle of quantum mechanics is the notion that particles, like electrons, can simultaneously occupy multiple states and positions until they are measured or observed—a phenomenon referred to as superposition. This behavior influences potential energy, which in a quantum context is not a fixed value but rather a dynamic state that can be harnessed for specific applications. Quantum mechanics is a general framework designed to describe the behavior of everything in the universe, from the smallest subatomic particles to the

vastness of galaxies. Exploring the original groundbreaking experiments that unveiled these principles alongside the advancements enabled by modern technology offers a fascinating perspective on the evolution of quantum science. The primary focus of quantum mechanics lies on phenomena uniquely characteristic of quantum theory, such as complementarity, entanglement, indeterminacy/uncertainty, locality, and dualism. Figure 1 shows a lists of uniquely characteristic of quantum theory.

1. **Complementarity:** In 1928, Niels Bohr proposed the principle of complementarity, highlighting its ontic interpretation as a fundamental concept in quantum mechanics. This principle has since been adapted and applied across diverse disciplines, including psychology and quantum cognition [34, 35]. To this end, several work has discussed the principle of complementarity developed by Niels Bohr, see, e.g., [36, 37, 38, 36, 39]. Bohr's principle of complementarity illustrates that when the wave-like nature of a system is observed, its particle-like nature remains concealed, and vice versa. It is fundamentally impossible to observe both aspects simultaneously, as the wave and particle characteristics are complementary. In quantum physics, this means that information derived from experimental setups, which cannot be executed simultaneously due to the physical constraints of the apparatus, cannot be fully represented within a single mathematically valid quantum state. Instead, the information obtained from incompatible measurements forms an essential and interconnected part of the quantum description. Based on this interpretation, it can be concluded that when the particle-like behavior of matter is observed or measured, its wave-like properties are inherently suppressed, and vice versa. The inability to simultaneously detect both the wave and particle characteristics of matter is what defines the principle of complementarity [40].

2. **Quantum entanglement:** This phenomenon, known as entanglement, occurs when two or more particles become interconnected such that the state of one particle is intrinsically linked to the state of the other, regardless of the distance separating them [41]. This instantaneous correlation appears to defy conventional notions of information transmission, which, under Einstein's theory of relativity, is constrained by the speed of light. Einstein famously described this effect as "spooky action at a distance," expressing his discomfort with its implications. Although quantum entanglement has been experimentally validated numerous times, its profound implications and potential applications—such as in quantum teleportation and quantum computing—remain active areas of research and exploration.

3. **Indeterminacy:** Recognized as one of the cornerstone principles of modern physics and a foundational element of quantum theory, the concept of indeterminacy was introduced in 1927 by the German physicist Werner Heisenberg [42, 43]. Heisenberg formulated this principle through his work on the mathematical foundations of matrix mechanics, which serves as a key representation of quantum mechanics [44]. Alongside Schrodinger's wave mechanics—viewed as the wave-based counterpart—matrix mechanics forms one of the two primary formulations of quantum theory. These approaches were later unified by the British physicist Paul Dirac. The principle of indeterminacy asserts that it is fundamentally impossible to simultaneously determine two properties of a quantum system—such as position and momentum—with perfect accuracy. Precise measurement of one property inherently increases uncertainty in the measurement of the other. This concept highlights the inherent limitations of knowledge, emphasizing that absolute precision in understanding or measuring all aspects of a quantum system is unattainable.

4. **Locality:** The principle of locality, rooted in Einstein's theory of relativity, posits that physical processes occurring in one location should not exert an immediate influence on the reality of distant elements [45]. However, a series of experiments has clearly demonstrated violations of this principle. These violations have inspired groundbreaking ideas, including the exploration of the universe beyond three dimensions (3D). This line of thought has further evolved into theories such as the many-worlds interpretation and superstring theory, both of which offer profound insights into the nature of quantum reality and stand as pivotal interpretations in modern physics.

5. Dualism: Wave-particle duality is the concept that all matter and energy exhibit wave-like and particle-like properties. Duality, a fundamental principle in quantum mechanics, highlights the limitations of classical notions like “particle” and “wave” in capturing the full behavior of microscopic entities [46]. Given the inherent unpredictability of a designer’s future decisions, conflicts between the present rational proposal and potential future system states are unavoidable. Rather than attempting to construct an overly simplified model of the designer’s decision-making process, a more adaptive approach is required to address this complexity [47].

The principles of quantum mechanics offer architects a powerful framework to rethink building design, enabling a focus on both visible and invisible energy interactions within spaces. Unlike traditional design approaches, which typically account for only physical and sensory aspects, quantum-inspired design considers how electromagnetic fields, energy frequencies, and other imperceptible influences impact occupants’ experiences and wellbeing [48]. By integrating these subtle energy dynamics into architectural planning, designers can create spaces that respond to users’ needs on a deeper, more holistic level. For example, facades could be engineered to adapt not only to changing light and temperature but also to shift in response to energy fields or frequencies that might affect a user’s comfort and mental state. This layered approach, where architecture is shaped by both tangible and intangible forces, opens up new possibilities for adaptive environments that enhance physical and energetic harmony for the building’s occupants

2.2. Integrating Quantum Potential Energy with Adaptive Systems

Quantum potential energy offers a theoretical foundation for enabling adaptive responses in facade systems. In architecture, the principles of quantum potential energy inspire new ways to design adaptive systems, particularly facades that respond dynamically to environmental changes. Quantum-inspired adaptive facades can harness energy fluctuations at microscopic levels, leading to materials that change properties—such as transparency, reflectivity, or thermal insulation—in response to external conditions. This concept drives the design of facades that require minimal active energy inputs, as they adapt naturally to fluctuations in sun- light, temperature, and air quality. By integrating quantum potential energy principles, facades could incorporate smart, self-regulating components that dynamically adjust shading, transparency, or insulation. This adaptability would surpass conventional mechanical or static systems, achieving higher efficiency and precision. Such applications highlight the potential of quantum energy concepts in driving the next generation of sustainable and intelligent building designs. A quantum-inspired facade could adjust its opacity in response to sun- light, effectively reducing the building’s cooling demands.

The term magnetic architecture refers to the integration of magnetic materials and principles in architectural design to create adaptable, dynamic, or functional structures [49]. Magnetic architecture involves the use of magnetic fields and properties to achieve various objectives, such as reducing mechanical friction, enabling movable components, or enhancing structural efficiency. One of the most notable applications of magnetic architecture lies in creating dynamic facades, movable walls, and adjustable building components. For instance, magnetic levitation (maglev) technology, can be employed to facilitate frictionless movement in sliding panels, partitions, or even entire structural elements. This approach enhances flexibility in space utilization and offers innovative possibilities for adaptable building systems. Using magnetic materials in adaptive building facades could be very helpful to control the amount of light and heat entering the building [5, 50]. By applying an electric current to magnetic materials, their transparency and reflectivity can be adjusted, regulating the amount of sunlight and reducing the need for heating, cooling, and lighting systems. This would indeed contribute significantly to the future architectural design. Using magnetic materials could be very helpful to capture and convert wasted energy into usable electricity.

Sustainable adaptive facades reflect a commitment to energy-efficient architecture that meets functional needs while prioritizing ecological balance. Therefore, achieving sustainability in the building industry, particularly with regard to energy efficiency and climate change mitigation, has therefore

become imperative [51]. As a result, sustainable practices in architecture are gaining increased importance due to the rise in energy demand and the escalating impacts of climate change [52]. To minimize environmental harm and reduce dependence on non-renewable resources, it is vital to design buildings with a strong focus on sustainability. Quantum-based energy solutions can enhance the sustainability of building systems by efficiently harnessing and distributing renewable energy sources. This begins with climate-responsive designs that adopt passive strategies, maximizing natural resources like sunlight, heat, rain, and wind [52]. Consequently, sustainable architectural designs must take precedence to mitigate the negative effects of climate change [9]. The shift towards environmentally conscious building design continues to evolve, driving the creation of sustainable architectural solutions [53].

The exploration of quantum energy capture and utilization represents a promising frontier in sustainable architecture [54]. Quantum energy, which refers to the subatomic energy fluctuations inherent in particles and waves, offers a unique potential for integration into architectural systems. Mechanisms to harness this energy could involve advanced materials such as quantum dots, graphene, or nanostructured semiconductors [55]. These materials have the capability to interact with quantum phenomena, such as tunneling or energy transfer at the nanoscale, making it feasible to design structures that actively generate energy from environmental fluctuations, including light, heat, or electromagnetic waves. Integrating such materials into building facades or roofs could revolutionize how energy is produced and consumed in urban settings.

While conventional systems primarily depend on static designs and external energy inputs, quantum potential energy introduces a paradigm shift to optimize energy efficiency. This approach enhances the functionality of adaptive facades, demonstrating its potential to redefine energy capture and utilization. Quantum potential energy enables systems to adapt to changing environmental conditions, improving overall energy efficiency. This adaptability represents a significant step forward in sustainable building technologies.

Traditional facades often lack the flexibility to adjust to environmental fluctuations, resulting in reduced energy performance under varying conditions [56]. Moreover, current energy-efficient systems come with their own set of limitations. These technologies often require high initial costs, regular maintenance, and can be complex to retrofit into existing buildings [57]. In addition, they may not perform as effectively under all environmental conditions, thus limiting their universal applicability. However, simpler adaptive systems demonstrate effective energy management without relying on external power sources [58]. Although conventional systems currently dominate practical applications due to their established frameworks, the integration of quantum potential energy principles presents a promising direction for future facade designs. This evolution aims to combine the reliability of traditional systems with the groundbreaking capabilities of quantum-inspired designs hence providing more sustainable and efficient buildings.

2.3. Quantum-Inspired Architectural Design

Quantum-inspired architectural design draws from principles in quantum mechanics as inspiration for new ways of designing buildings and materials with potentially adaptive and sustainable properties. For instance, by applying quantum principle, architects could conceive materials that allow facades to adjust dynamically to environmental changes, possibly utilizing energy states more efficiently than conventional materials [50]. Quantum-inspired architectural design allows to rethink how we approach building materials and adaptive structures. In traditional architecture, materials are typically selected for their durability, strength, and aesthetic qualities. However, quantum mechanics introduces a new way of understanding materials at the molecular level, where particles can exist in multiple states and respond to environmental changes in unique ways. Through quantum-inspired design, architects explore the potential for materials to be more than passive components in a structure—they envision materials that actively respond to changes in temperature, light, and other external conditions. Quantum-inspired architectural design thus represents a bridge between scientific advancement and

practical application, allowing the built environment to adapt seamlessly to its surroundings in ways that traditional materials simply cannot.

The term quantum architecture explores the integration of advanced materials and dynamic systems inspired by quantum mechanics to create responsive and adaptive structures. The main aim is to design facades and architectural elements that can actively respond to environmental changes. Quantum architecture emerges from the interplay of human consciousness and energy forces can offer a new dimension to sustainable building practices. In architecture, the concept of a quantitative system is interpreted as the embodiment of consciousness—an awareness of the surrounding environment and its conditions. For a building to attain a sense of timelessness or “immortality,” it must harmoniously adapt and respond to external influences that shape or impact its built environment, both in the present and the future. The theory of quantum mechanics in architecture focuses on the idea that architectural design is a transformation of formal and spatial elements, according to their natural harmonic sustainability. When a quantitative relationship occurs in architecture, two or more activities harmoniously engaged in a changing relationship with each other and with the context that affects them, their separate roles will act jointly, thus becoming cooperating individuals. This will have harmonic oscillations back and forth from one to the other, to maintain their cooperative mission [59]. Quantum construction aims to establish a cooperative relationship with the forces of the natural world, embracing the inherent indeterminacy of quantum mechanics.

Quantum aesthetics are expressions of architectural reason and utility. There are communications between a building and its user that demonstrate an appreciative dialogue, as the quantum building declares its purpose and function, and the quantum user sees, accepts, and enjoys the building for what it is. When a building succeeds in promoting positive human consciousness, it is in a give-and-take dialogue with its external, contextual influences.

While traditional science often focuses on phenomena observable through the five senses, quantum mechanics reveals a deeper, often unseen world where energy fields, frequencies, and forces interact in ways beyond direct human perception [60]. These subtle energies, such as electromagnetic fields, can profoundly influence the spaces we inhabit, even if they aren’t consciously sensed. The work in [61] investigated the phenomenology of interior spaces, focusing on their emotional connection to human experiences. In addition, the work explored the key aspects that influence how people perceive and interact with interior spaces, identifying factors that enhance the quality of both spatial and emotional experiences. The research emphasizes that interior spaces can effectively stimulate emotional engagement, fostering a deeper spatial understanding of architecture. The paper outlined three primary methods for enriching interior experiences: Stimulating the lived body, Highlighting the role of materiality, and Encouraging emotional connections. These approaches enhance individuals’ sensory awareness of interior spaces, thereby improving the quality of their emotional interactions with the environment. Through representative case studies, the research investigated how materiality evokes sensory effects and how multi-sensory spaces contribute to emotional engagement. The results indicated that integrating bodily awareness and materiality is essential to enriching spatial experiences, even in abstract contexts that lack traditional architectural forms. Ultimately, this work advances the understanding of the interplay between interior spaces and human experiences, shedding light on how multi-sensory designs can improve emotional and spatial quality. Moreover, indoor measurements of the Earth’s magnetic field indicate fluctuations in both strength and orientation, offering valuable insights into the interaction between these fields and architectural designs [62]. With the development of theories that deal with quantum physics [63, 48], it has become possible to benefit from unconscious and interacting energy influences to reach conscious awareness through two types of energy, which can be demonstrated as:

1. The energy transmitted by any particle present in this universe.
2. Electromagnetic energy fields in architectural spaces emanating from the interior of the Earth or the materials that make up the space itself [64].

3. Adaptive Facade Systems in Architecture

This section discusses the adaptive facade concept in architecture design. adaptive facade have been described in the literature using a variety of terms, such as responsive, dynamic, adjustable, advanced, interactive, controllable, intelligent, innovative, sensitive, smart, modifying, movable, active, reactive, transient, kinetic, reconfigurable, transformable, accommodating, polyvalent, switchable, and selective facades [65, 66]. Fixed or static shading systems have a limited capacity to adapt to changing indoor or outdoor environmental conditions throughout the day or across seasons, which can lead to poor performance if operating requirements evolve over time [67, 68]. Non-flexible facades that enhance daylight penetration by increasing transparency often result in issues such as glare or overheating, prompting occupants to make adjustments that reduce indoor comfort and compromise long-term energy savings [69]. While conventional windows suffice for basic daylight entry, achieving deeper natural light penetration into interior spaces necessitates more advanced and responsive design solutions.

The current standards evaluate building envelopes under constant climatic conditions, adaptive facades offer a dynamic response to changing climates. For example, the works in [70, 71, 72, 73, 74, 75, 76, 77, 78] investigated single performance parameters of facades. While these studies contribute to an extensive body of knowledge on facade performance, they predominantly address static facades rather than adaptive ones. However, the emphasis should shift toward adaptive facades to better align with dynamic environmental needs. Adaptive facade elements designed to self-adjust to different purposes, due to the materials' automatic response to the environmental stimulus. These elements operate in intrinsic mode, with no sensors, actuators, external power, or human action needed (e.g., facades containing phase change materials, shape memory alloys, thermochromic coatings) [79, 80, 81]. The concept of adaptive building facades technologies is considered as an opportunity to reduce the demand of buildings energy and reduce CO₂ emissions [82]. Thus, adaptive facade systems will present several opportunities to enhance the quality of indoor environmental. In particular, facades are a crucial component of buildings, significantly impacting energy efficiency and occupant well-being [83].

3.1. Overview of Adaptive Facades

The term "facade" originates from French, meaning "frontage" or "face" (Simpson, 1989 a, b) [16]. Facade refers to the exterior surface or skin of a building, encompassing any unique architectural elements [84]. Facades play a critical role in regulating energy consumption by balancing the heat exchange between indoor and outdoor environments. The materials used to create facades have transitioned from traditional ones such as clay, stone, wood, and brick, to more modern materials like steel and glass to address diverse functional and climatic demands. Over time, the materials and design techniques for facades have evolved to improve their performance in terms of energy efficiency, thermal comfort, and adaptability. As such, this advancement in materials and construction methods has led to the development of various facade types [85, 85]. Besides, the recognition of the building envelope's significance in managing and optimizing energy consumption has increased over time [86]. As a result, facades are no longer seen as passive barriers but as active components in regulating a building's energy balance [86]. Modern facades not only serve as a protective layer but also actively regulate natural light, ventilation, and temperature, often incorporating advanced technologies like kinetic elements, photovoltaic systems, and biomimetic designs inspired by nature [16]. This shift requires facades to be adaptable to changing environmental conditions [28]. In particular, facades that adapt to immediate environment can improve both versatility and energy efficiency, reducing operational energy requirements. In this way, facades should function similarly to natural skins [87], much like living organisms adjust to fluctuating weather while maintaining their internal temperature within specific limits through physiological, morphological, or behavioral thermoregulation mechanisms [88]. Biomimicry offers significant potential as a design strategy to enhance a building's sustainability [89].

Adaptive facades are building envelopes that can adapt to changing climate conditions on an hourly, daily, seasonal, or annual basis. The word adaptation means the ability to interact or take advantage of

external climatic conditions to meet productivity and mainly to successfully achieve the comfort and well-being of the occupant [90]. Adaptive facades can be defined as an innovative architectural solution designed to adapt to changing environmental conditions, improving both energy efficiency and occupant comfort. These facades automatically adjust their properties, such as light transmittance and ventilation, in response to factors like sunlight, temperature, and wind. By regulating heat and light, adaptive facades reduce the reliance on Heating, Ventilation, and Air Conditioning (HVAC) systems and artificial lighting, leading to energy savings of up to 50%. They also enhance the visual aesthetics of buildings while maintaining a comfortable indoor environment. This integration of smart technology with architecture offers a sustainable approach to building design, significantly lowering CO₂ emissions and operational costs [15].

Facades play a critical role in construction, influencing energy efficiency, environmental impact, and indoor space quality while serving as a bridge between a building's interior and exterior. Although facade engineering integrates fields such as structural and chemical engineering, material science, and building physics, the construction sector must rapidly adopt advanced adaptive facade technologies to reduce environmental impact and enhance user experience [83]. The movement of kinetic facades is often controlled by built-in sensors and actuators, which trigger changes like rotating, sliding, or folding in response to real-time environmental data. This adaptability allows buildings to maintain energy efficiency, as the facade adjusts to minimize heat gain or loss, reduce glare, and maximize natural light. In essence, kinetic facades act as a mediator between the interior and exterior environments, actively managing energy flows and enhancing sustainability. This smart approach not only conserves energy but also improves the overall user experience by creating comfortable, energy-efficient spaces.

Researchers have explored the effects of adaptive facades on occupant comfort and satisfaction [91, 92], examined different technologies implemented in dynamic facade systems [93, 94], categorized adaptive facades within kinetic architecture [95], assessed their daylighting efficiency [96], and investigated their effectiveness in providing sun shading [97]. Loonen in [98] defined them as multi-purpose, high-performance envelopes that respond mechanically or chemically to external climatic dynamics, unlike fixed curtain walls, to meet the requirements of internal loads (cooling, heating, lighting, or ventilation) and user needs. Adaptive facades can provide incremental upgrades in energy efficiency and use of renewable energy while improving building comfort for users [99]. It refers to the use of magnetic materials or magnetic properties in the design of building facades in ways that help regulate the amount of light and heat that enters the building. This technology allows the transparency and reflectivity of magnetic materials to be adjusted by applying an electric current to them, allowing control of the amount of solar light emitted and reducing the need for heating, cooling, and lighting systems.

Adaptive facades play a crucial role in minimizing glare and controlling solar radiation, thereby enhancing occupant comfort while simultaneously lowering energy consumption. Examples of such applications includes the Kolding campus of Southern Denmark University, the innovative Blinking Sail facade, and the Hybrid Responsive Facade [100, 101, 102]. Some dynamic facade designs, such as those implemented in the Hybrid Responsive Facade and the Kiefer Technic Showroom, enable occupants to customize their immediate surroundings, thereby enhancing overall comfort and user satisfaction [103, 104]. The Hybrid Responsive Facade merges the mechanical movement of facade elements with material innovations, such as thermochromic or photoresponsive layers, to achieve multi-faceted adaptability [105, 106].

The facade integrates passive and active strategies to optimize energy performance. Passive measures, such as shading devices, minimize solar gain, while active systems dynamically adjust elements to achieve energy efficiency. The design prioritizes occupant experience, enhancing natural light penetration and visual connectivity to the outdoors. This creates a healthier, more engaging indoor environment, aligning with principles of biophilic design. Adaptive facades play an essential role in enabling users to manage their personal environment, privacy, and external views to meet their comfort needs [83]. Conducting post-occupancy evaluations of adaptive facades systems is essential to

examine how users interact with or exercise individual control over HVAC systems and building management systems (BMS). Despite efforts like soft-landing approaches and user education, a significant barrier to achieving occupant satisfaction persists due to a lack of understanding about operating or engaging with adaptive facades [107]. Within any automated dynamic facades, ensuring that users can control their indoor environment is of utmost importance [108, 109].

The work in [110] highlighted the significant environmental benefits of adaptive facades, showcasing their ability to markedly reduce CO₂ emissions and minimize the use of construction materials. By optimizing energy efficiency and resource utilization, adaptive facades not only contribute to sustainable architectural practices but also address pressing environmental challenges associated with traditional building systems. Case studies, such as the Al Bahr Towers, strongly affirm the advantages of adaptive facades in enhancing building performance. These innovations have demonstrated measurable reductions in solar radiation, CO₂ emissions, and solar heat gain, underscoring their role in fostering energy-efficient and environmentally responsible design [103, 100].

The author in [103] categorized dynamic facades into four primary types based on their functional objectives: User-Control Dynamic Facades, which allow occupants to directly influence their environment; Light-Control Dynamic Facades, designed to optimize natural light and reduce glare; Energy-Control Dynamic Facades, aimed at regulating thermal energy for enhanced efficiency; and Water-Management Dynamic Facades, which address water-related challenges such as rain protection and water harvesting. These classifications highlight the diverse capabilities of dynamic facade systems in responding to environmental and user needs while advancing sustainable design practices.

The work in [83] introduced an evaluation framework incorporating key performance indicators (KPIs) designed to organize the assessment of requirements, performance benchmarks, and qualitative technical attributes of adaptive facades systems, taking into account their multi-domain scope and the involvement of diverse stakeholders. In addition, the paper also classified the dynamic facades performance parameters into five different categories. These categories are: 1) energy and environmental performance, 2) protective performance, 3) building control and services, and 4) user control and experience. The proposed framework emphasized the significance of prototyping, testing, and inspecting facades while identifying a key issue: adaptive facades systems are often designed at the product or component level rather than the building level.

3.2. Potential of Kinetic Energy

The Kinetic facades are building envelope systems designed with dynamic, movable components that can change position, shape, or configuration in response to specific inputs such as environmental conditions or user needs [111]. In particular, kinetic facades integrate movable elements, which have the ability to be adjusted based on climatic conditions. Therefore, this would significantly improve thermal regulation compared to static facade [112]. Kinetic facades often utilize mechanical systems to achieve their motion, allowing for adjustments in shading, ventilation, or day lighting. Kinetic shading systems adjust light and heat entry, significantly reducing energy consumption and CO₂ emissions [113]. While Kinetic facades share similarities with adaptive facades in their goal of enhancing building performance and user comfort, the key difference lies in their functionality. Adaptive facades encompass a broader category that includes not only kinetic elements but also systems driven by material properties, sensors, and automation to react passively or actively to changing conditions [114].

Potential energy refers to the stored energy of an object at rest, influenced by its position relative to other objects, while kinetic energy represents the energy of motion. For instance, a brick suspended from a height possesses greater potential energy than one resting on the ground. In the late 19th century, some natural philosophers argued that potential energy could be interpreted as an apparent form of kinetic energy, emphasizing motion as the essence of all energy [115]. This perspective aligns with the idea that physical sciences aim to explain phenomena through the motion of matter. In the context of kinetic facades, this interplay of potential and kinetic energy

mirrors the transformation of static facade components into dynamic, functional systems that respond to environmental or operational demands.

The traditional notion of potential energy as a separate entity has been reinterpreted as a manifestation of kinetic energy, highlighting motion as the core essence of energy. This perspective is reflected in practical systems like potential energy engines, which interconvert kinetic and potential energy, and gravity-based storage systems that utilize vertical weight movement to harness gravitational energy [116]. Theoretical approaches, such as inverse perturbation analysis, refine potential energy surfaces in molecular dynamics, while energy management systems in high-potential devices optimize energy use. Though this kinetic-centric view offers a unified understanding, it may underappreciate the unique roles and applications of potential energy across various technological and natural system

Heisenberg's uncertainty principle introduced the concept of indeterminism [117], which states that it is fundamentally impossible to simultaneously measure both the position and velocity of a quantum particle with infinite precision [118, 119]. This principle is not just a limitation of measurement but reflects the inherent nature of quantum systems [120]. The principle explains that reducing uncertainty in one property leads to greater uncertainty in the other, emphasizing that absolute precision is unattainable.

According to Webster's findings in [121], a system that lacks inherent potential energy may still appear to possess it if we are unaware of the underlying motions within the system. The material contributing to what is observed as kinetic energy can either be a component of the system itself or originate from an external system. This insight emphasizes that our perception of energy within a system is deeply influenced by the presence and recognition of motion, underscoring the nuanced relationship between kinetic and potential energy.

As discussed in [122], efforts to address the problem of localizing potential energy remain challenging. While this limitation persists, an intriguing avenue in physical science explores applying these concepts within quantum mechanics.

Kinetic facades is part of dynamic facades, which are defined as dynamic architectural elements designed to adapt to changing environmental conditions, enhancing both the functionality and aesthetic appeal of buildings [123]. Unlike static facades, kinetic systems use movable components, such as panels, louvers, or shading devices, that can adjust in response to factors like sunlight, temperature, or wind. This adaptability allows buildings to optimize natural light, control interior temperatures, and reduce energy consumption. An adaptive building skin involves a morphogenetic evolution and the ability to physically adapt in real time based on the surrounding environment [124, 69, 125, 126]. Kinetic facades utilize kinematic technologies, employing mechanical or electro-mechanical actuators [127, 128, 129], to adjust their configuration in response to changes in the building's ambient climate, aiming to enhance occupant comfort and productivity [130]. These facades incorporate biomimicry principles to achieve complex, flexible, and foldable designs using smart and semi-transparent materials. Additionally, they help reduce the impact of direct sunlight, which is at least five times more intense than diffused light [131]. The facade's shape, driven by the responsive system, can be altered through elastic deformation [132, 133, 134], movable components, shape-changing panels, and self-shading geometries [135, 136, 137]. By regulating the amount of heat and light that enters a building, kinetic facades help maintain comfortable interior environments while minimizing reliance on mechanical heating and cooling systems. These facades not only support energy efficiency but also offer architects creative flexibility, enabling innovative designs that interact actively with the surrounding environment. Overall, kinetic facades represent a forward-thinking approach to sustainable and responsive architecture, aligning buildings with modern energy goals and occupant needs.

The work in [138] investigated dynamic photovoltaic building envelopes designed to optimize energy generation, comfort, and operational efficiency in buildings. The authors introduced a lightweight modular facade system equipped with hybrid hard/soft-material pneumatic actuators

capable of precise solar tracking. By adapting the position of integrated thin-film photovoltaic panels to real-time environmental conditions, these dynamic envelopes enhance energy efficiency and occupant comfort through local energy generation, passive heating, shading, and daylight modulation. Prototypes tested under varying climates, such as temperate and arid regions, demonstrated significant energy gains—up to 50% compared to static photovoltaic systems—and reduced energy demands by up to 19 percentage points in optimized configurations.

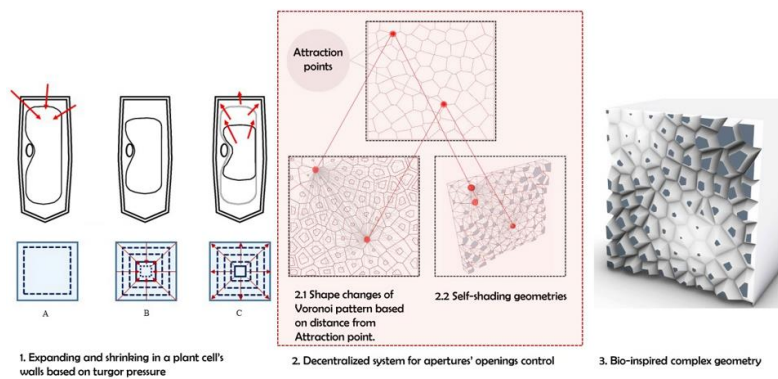

Figure 2.

Development of a modular control of the eccentric interface inspired by the pressure of plant cell wall distension [141,142].

The work in [139] focused on developing adaptive building envelopes inspired by natural systems. The author utilized a biomimetic approach to create building facades that can respond effectively to environmental changes. The study also investigated how specific natural morphologies regulate heat, air, water, and light, providing a framework for designing more adaptable and efficient building envelopes. By examining various organisms that thrive in harsh conditions, the paper identified strategies from nature that can be translated into architectural solutions. The goal was to enhance the environmental adaptability of buildings using design concepts based on the morphological features of natural systems. Finally, the author in [139] concluded that "form follows environment," the replication of the extensibility of plant cell walls using Voronoi patterns leads to the creation of a bio-interactive and complex facade design. Figure 2 demonstrates a replicate the extensibility of plant cell walls using Voronoi patterns to create a bio-interactive and complex facade design. This facade design can dynamically adjust its scale and extend modular components to control daylight in real time. The facade must be dynamic, guided by a responsive decentralized system, to adapt its form locally based on the sun's position throughout the day. Since responsive facades need to react to both external and internal stimuli, the adaptive strategies of plants can serve as a valuable inspiration for creating interactive kinetic facade designs that enhance the visual comfort of occupants [140].

The research in [141] is also studied the morphological approach to biomimetic, and parametric daylight simulation to develop a multi-layer biomimetic kinetic interface shape, inspired by the morphology of trees to improve daylight performance for the user. To explore how biomimicry affects the functions of the kinetic interface, the study applied the biomimetic morphological approach to derive tree morphological strategies due to dynamic day lighting, and in terms of functional convergence, the principles of biomimetics were translated into the Figure 2: Development of a modular control of the eccentric interface inspired by the pressure of plant cell wall distension [142, 141].

The extracted shapes and motions are translated into kinematic interface design solutions resulting in the flexible shape using cross- and multi-layer shells and kinematic vectors with

bending motions. Figure 2 shows the development of a modular control of the eccentric interface inspired by the pressure of plant cell wall distension [142, 141]. Design rules derived from biological systems provide an opportunity to achieve a tunable configuration that changes from stationary to kinetic phase. In this study, biometrics (tree morphology) were explored through the morphological approach of biomimetics [143].



Figure 3.
The Shed at Hudson Yards [144].

The work in [144] proposed the tectonics of kinetic architecture, moving structure, and changing space, as buildings today are no longer frozen musical pieces as they can move, rotate, flip, and perform different physical gestures. The study aims to explore the spatial, aesthetic, and technical characteristics of kinetic buildings within the framework of tectonic theory. The paper focused on the interrelationships between tectonics and the physical movement of architectural elements. The results indicated that the type of movement and the role of moving elements change not only the architectural space but also the tectonic character of the building. While some movements and moving parts are directly related to representational aspects, some change the existential character of the building. The study is concerned with clarifying the theory of tectonics in parallel with the evolution of structural needs for adaptation. The performance of this type of building, which is already called kinetic, cannot be easily explained in relation to purpose but as manifestations of technological progress. The advantages of this type of design can be significant: it lasts longer, performs its function better, accommodates users' experience and intervention, takes advantage of technological advances more easily, and is more economically and environmentally feasible [145]. In some kinetic buildings, movement is driven by data automation managed through sensors. The speed at which the moving parts operate affects perception, appearing either as a rhythmic motion or as subtle changes that are barely noticeable. Most responsive facade systems incorporate digitally assembled movement with a sense of continuity. However, mechanically assembled movements create a more dramatic transformation in the spatial and temporal experience, as seen in structures like demountable buildings (e.g., circus tents) or convertible bridges. For this reason, the movement in The Shed is considered a mechanically assembled type. This mechanical nature is what creates a noticeable tension between tectonic (structured) and atectonic (fluid) elements. Figure 3 shows The Shed at Hudson Yards; which was taken by Iwan Baan, reprinted with permission of The Shed/Diller Scofidio + Renfro as mentioned in [144]. Noting that The Shed stands as one of the most ambitious projects to achieve this level of transformation in a building, accommodating between 1,750 to 3,000 spectators simultaneously,

and has become a landmark in the history of kinetic architecture. Further discussion about The Shed can be found in [144].

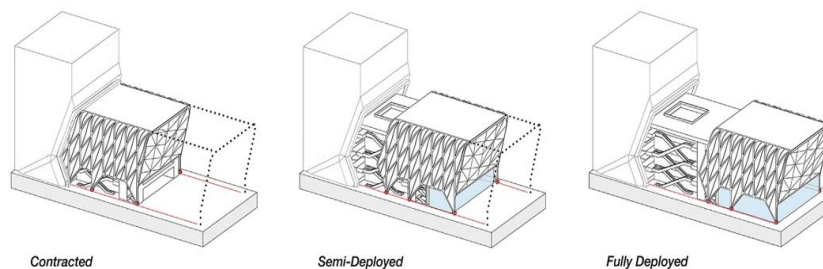

Figure 4.
Deployment of the Envelope by moving cover [144].

In addition, the placement of the moving components and motor system plays a crucial role in the overall tectonic expression. What makes The Shed unique is its kinetic facade, which envelops the conventional fixed mass of the building. The kinetic envelope functions like a massive gantry crane, resting on two rows of rails on the ground and supported by six large bogie wheels. Unlike similar structures, the motors that drive the movement are not positioned near the rails or bogie wheels but are instead located at the top of the kinetic facade. This top-down activation process is similar to the operation of a "shopping cart," where the force comes from the top. The entire movement takes about five minutes, traveling at a speed of a quarter-mile per hour, while the full extension and retraction process takes around four hours and requires a crew of four to six people. In essence, this movement can be categorized as a horizontal deployment with activation starting from the top and working downward.

Another key aspect that influences the perception of tectonics in kinetic buildings is the scale of the transformation. During the extension process, the kinetic shell slides mechanically from a position where it fully covers the stationary conventional building to one where it largely reveals the fixed structure. This results in a significant mechanical shift, increasing the building's footprint by 86%. Thus, the kinetic facade of The Shed has the potential to create more profound ontological changes in the architectural space and the tectonic character of the building compared to other similar structures as shown in Figure 3. Besides, Figure 4 demonstrates the deployment of the envelope by moving cover [144]. The work in [146] presented Roth's method of non-negligible coordinates that demonstrates that the quantum potential energy involved in particle interactions, which accounts for quantum effects, can be understood as the kinetic energy of additional "hidden" degrees of freedom. This method offers an alternative view to the Planck constant, which plays the role of a hidden variable. The research presents a model that has proof of concept status. However, the work does not provide any explanation for the shape of the density-dependent factor in hidden kinetic energy or for the value of the Planck constant if a similar change in the definition of the hidden initial speed is made. Instead of interpreting hidden variables as relating to a discrete physical system, they may be allowed to represent internal freedoms (such as rotation) or spatial coordinates in higher dimensions. The theory is closely related to the Kaluza-Klein program [147]. One interesting aspect of subtle motion, however conceived, is that it is described by a continuity equation corresponding to quantum flow but where the density differs from the quantum expression (probabilistic) expression. Physical phenomena must be considered to occur within space and time, one of the problems recognized with potential energy has been the difficulty of locating it, i.e. dividing it into specific regions of space.

It has been proposed to treat potential energy as a representation in the visible coordinate field of the kinetic energy of hidden movements whose character cannot be fully determined. The matter

whose motion constitutes the kinetic energy may be either part of the system or a system external to it [146]. Adaptive facades, while innovative, come with a some of challenges that need to be considered in future. One major issue is noise generation; for example, dynamic facade systems like those at the Arab World Institute can produce considerable noise when moving components are in operation, potentially disturbing occupants [148]. In some cases, adaptive facades, may have slow response times to environmental changes, limiting their effectiveness [148]. Complex designs, especially those with multiple moving parts like the Arab World Institute's facade, also demand more frequent maintenance, which may compromise their long-term viability [148]. Another concern with adaptive facades is design rigidity; fully automated systems may restrict user control, which can be undesirable in occupant-centered designs [149]. In addition, the lack of long-term data on life-cycle costs and performance can be a barrier for investors, who often require robust evidence to justify such investments [150]. Some adaptive facades, like those at Galleria Centercity and Eskenazi Hospital, also fall into the category of pseudo-dynamic designs, where aesthetics are prioritized over functional adaptability, which may reduce their perceived value [151]. Furthermore, energy consumption is a concern for certain adaptive systems, particularly electroactive polymer facades, which can demand substantial operational energy [148, 150].

4. Case Studies and Experimental Applications Considering Adaptive Facades

Adaptive facades have gained widespread popularity in the global construction and building sectors. These facades are implemented in various countries to enhance energy efficiency, improve visual appeal, or achieve a blend of both objectives. In addition, the impact of magnetic fields on comfort zones in such facades designs has been explored. Considering the diversity of building designs, it is essential to conduct tailored studies for each type, separating the magnetic effects originating from the ground from those caused by electrical systems within the structure. This approach emphasizes the expansive and multifaceted concept of energy across various fields, including architecture. Generally, energy is associated with natural processes and the capacity to perform work, existing as either potential or kinetic energy, and manifesting through both natural and human-made systems. This section presents several case studies that considered adaptive facades. Figure 5 shows a lists of case studies that are considered in this paper.

4.1. Toward an AI-Powered Academic Assistant

The Sharifi-ha House can be considered as an example of movable facade. The Sharifi-ha House located in Tehran, Iran, features a dynamic facades composed of rotating boxes that respond to changes in ambient temperature [152]. Uncertainty and flexibility underlie the design concept of Sharifi-ha House. These boxes rotate outward during the summer, creating open, transparent spaces with large terraces. The dramatic and spatial qualities of the interiors, as well as the formal composition of their exterior, respond directly to the displacement of circulation boxes that result in the building volume becoming open or closed, acquiring an introverted or extroverted character [15]. These changes may occur according to the changing seasons or functional scenarios of the floor plans [153]. For example, during Tehran's cold and snowy winters, the boxes rotate inward, closing off the facade to minimize openings and eliminate terraces. When the kinetic boxes in Sharifi-ha's apartment move, not only the spatial setting within the apartments grows and contracts but also the total area of the balconies and open spaces.

In these examples, the movement creates existential changes for the host buildings. Figure 6 shows a diagram of Sharifi-ha House with the open/closed volume of the building, which would serve as dynamic seasonal patterns of housing.

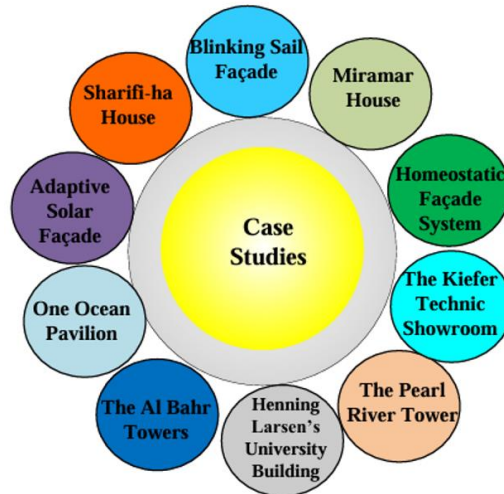

Figure 5.
Lists of case studies that are considered in this paper.



Figure 6.
A diagram of Sharifi-ha House.

The openness/closeness of the building volume is a reference to traditional Iranian houses, which would dynamically function as seasonal patterns of housing by introducing (winter living room) and (summer living room) into their homes. The house is distributed over seven floors: the lower two floors are dedicated to family living, fitness facilities, and wellness areas, while the ground floor houses parking and housekeeping rooms. All public activities take place on the first and second floors, and the family's private life takes place on the third and fourth floors. Figure 7 and Figure 8 show mechanism of opening and closing and the rotation different views of the Sharifi-ha House, respectively.

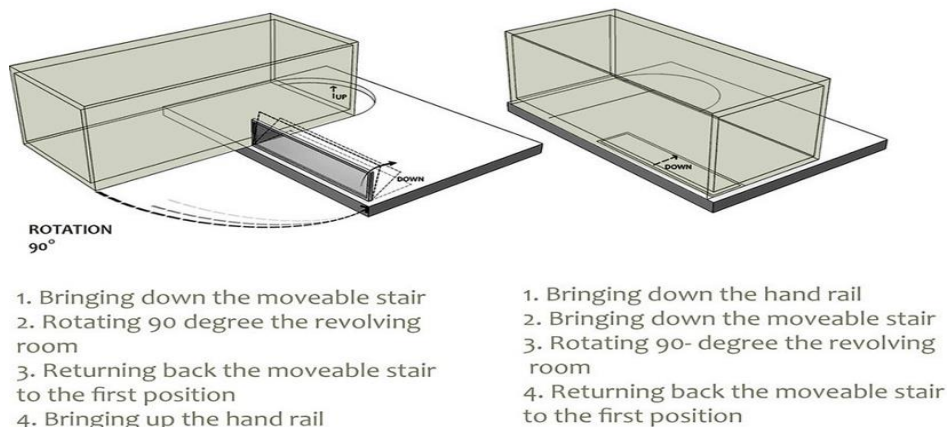

Figure 7.
The mechanism of the opening and closing the Sharifi-ha [154].

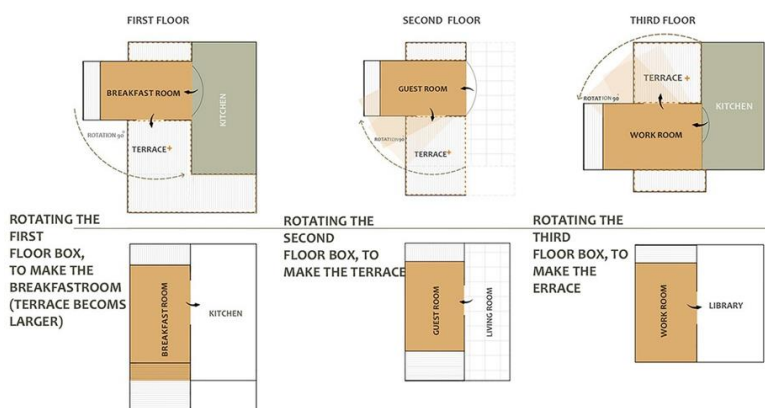

Figure 8.
The mechanism of the rotation of Sharifi-ha and its adaption to the functional needs of its residents [154].

Being partially mobile is the dominant feature of this structural assembly, as all the main loads fall on the beams of the living rooms. Due to the different configurations that recycling bins may take, the load calculation has been estimated based on the largest possible load value applied to the system. In addition, in order to prevent structural deformation controlling possible vibrations in the rotating boxes, was taken into account during the design/calculations of the structure. Figure 9 shows different views and interfaces of the Sharifi-ha House demonstrating how the design can adaptively changing based on the functional needs of its residents. The figure shows that the interface is narrow, hence converting the 2D interface into a 3D interface is indispensable.

4.2. Blinking Sail Façade

The blinking sail facade is an iconic dynamic structure located on the Esentai Tower in Almaty, Kazakhstan. Designed by the architectural firm Skidmore, Owings & Merrill (SOM), this facade is a notable example of kinetic architecture, incorporating motion and adaptability to enhance the building's energy efficiency and visual appeal.



Figure 9.
Different views of opening and closing the Sharifi-ha House [154].

The concept of the blinking sail facade is inspired by the movement of a sail catching the wind. The facade is designed to mimic the undulating motion of a sailboat's sail, creating a dynamic and ever-changing appearance. The structure features a series of motorized, lightweight aluminum panels that can open and close in response to environmental conditions. This movement is not only visually striking but also serves a functional purpose in managing solar gain and optimizing indoor climate control. The Blinking Sail facade functions as an adaptive shading system that reacts to changes in sunlight and temperature. During hot and sunny periods, the panels close partially or fully to provide shade, reducing solar heat gain and minimizing the building's cooling load. Conversely, during cooler or cloudy conditions, the panels open up to allow natural light to penetrate the interior, reducing the need for artificial lighting and utilizing passive solar heating. This adaptive mechanism helps to maintain a comfortable indoor environment while significantly enhancing the building's energy efficiency. The facade is controlled by an automated BMS that uses sensors to monitor sunlight, temperature, and wind speed. The system adjusts the movement of the panels in real time, ensuring optimal shading and light levels throughout the day. This responsive behavior helps to reduce energy consumption for heating, cooling, and lighting, aligning with sustainable building practices. The BMS also allows for manual overrides, giving building managers the flexibility to adjust the facade based on specific needs or preferences.

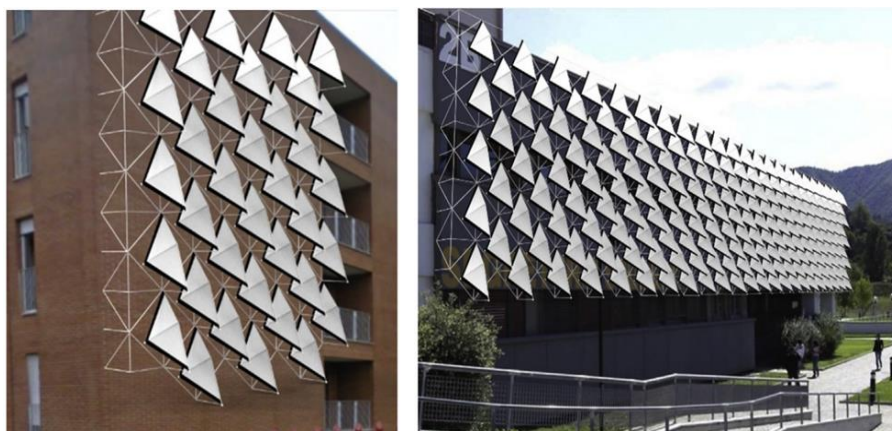

Figure 10.
Blinking sail facades with fully opened configuration [101].

The kinetic nature of the facade creates a dynamic, shimmering effect that changes with the movement of the panels, making the building appear as if it is constantly "blinking" in response to the environment. This dynamic visual quality not only enhances the aesthetic appeal of the building but also serves as a striking example of how kinetic architecture can merge form and function effectively.

The blinking sail facade exemplifies the potential of adaptive kinetic facades to improve both the

energy efficiency and aesthetic value of modern buildings. By integrating an automated shading system inspired by natural movements, the facade provides an innovative solution for climate control while offering a visually engaging experience. It stands as a benchmark for future developments in dynamic facade technology, demonstrating the effective use of adaptive design to meet both environmental and architectural goals. Figure 10 shows an example of blinking sail facades with fully opened configuration, which are able to harvest wind and solar energy from wind power generators [101].

4.3. Miramar House

The two-story Miramar house, located in Miramar, Portugal, is an example of architecture that seamlessly adapts to its Mediterranean climate [15]. The Miramar house is designed to respond to fluctuating weather conditions. This is achieved by leveraging its facade to optimize energy efficiency and enhance occupant comfort. The Miramar house embodies a thoughtful design that harmonizes with its surroundings. The facade in this design plays a crucial role in regulating the indoor environment by maximizing the use of natural daylight. Large openings allow ample sunlight to penetrate the interior, reducing the reliance on artificial lighting during the day. At the same time, strategic design elements provide privacy and shield the occupants from excessive solar heat, ensuring a comfortable living space.

The house also capitalizes on natural ventilation, with openings positioned to encourage cross-ventilation, which helps maintain a cooler indoor environment during the warm Mediterranean summers. This passive cooling approach minimizes the need for mechanical ventilation systems, further enhancing the building's sustainability. The facade's design ensures that solar gains are managed efficiently, balancing natural lighting and thermal comfort. Its integration of solar panels on the roof contributes to sustainability by providing renewable energy for heating the building's water supply, reducing overall energy consumption. By blending passive architectural strategies with renewable energy technology, the Miramar House demonstrates how adaptive facade principles can be applied to create sustainable and efficient residential buildings. Figure 11 shows the Miramar house.



Figure 11.
The Miramar house. The photo is taken by Jose Campos [155].

4.4. Homeostatic Façade System

The Homeostatic facade system, developed by Decker Yeadon, represents a pioneering approach to sustainable and responsive building design [156]. This innovative facade prototype embodies advanced material science and environmental adaptation principles, aiming to regulate internal building conditions in response to external stimuli. Below, we explore its significance in terms of architectural design and its role as an adaptive facade.



Figure 12. Homeostatic facade system a prototype photo (C)visual simulation courtesy of Decker Yeadon, NY [157].

The facade incorporates a specialized polymer embedded with dielectric elastomers. These materials expand and contract in response to electrical stimuli, allowing the system to adjust its configuration dynamically. This design showcases how advanced materials can revolutionize architectural possibilities. The Homeostatic facade System integrates seamlessly into a building's exterior, maintaining a sleek and minimalist appearance. Its design emphasizes form following function, creating a visually subtle yet technologically sophisticated facade.

Drawing inspiration from biological systems, the facade mimics homeostasis—nature's way of maintaining equilibrium. This concept is reflected in the facade's ability to balance heat gain and loss, contributing to a building's thermal comfort. The Homeostatic facade System is specifically designed to regulate solar heat gain. By expanding or contracting in response to environmental conditions, it controls the amount of sunlight entering the building, reducing reliance on artificial heating or cooling.

This design significantly reduces energy consumption. The self-regulating nature of the system eliminates the need for complex mechanical devices, lowering operational costs and environmental impact. Unlike traditional responsive systems that rely heavily on external power, the Homeostatic facade System utilizes minimal energy inputs. Its material-driven adaptability makes it an energy-efficient solution for sustainable architecture. Figure 12 demonstrates an example of homeostatic facade system.

4.5. Adaptive Solar Facade

The adaptive solar facade prototype at the Eidgenössische Technische Hochschule (ETH) House of Natural Resources in Zurich, Switzerland, incorporates humidity and illuminance sensors within the office space to monitor temperature and thermal comfort. Its thermal and electrical performance is evaluated by comparing it with an adjacent office building that uses a standard fabric-based shading system. By managing solar gains and optimizing natural lighting, the adaptive solar facade significantly enhances the building's energy efficiency [158, 159].

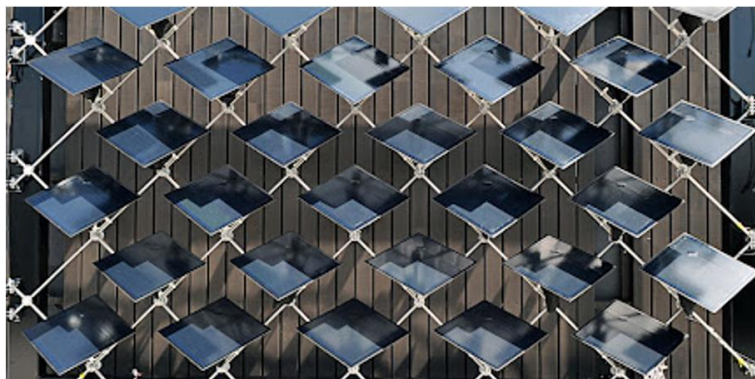

Figure 13.
Adaptive solar facade in Switzerland [160].

Using numerical models to simulate the prototype's performance, the developers achieved a 25% reduction in total energy consumption [158]. Furthermore, integrating photovoltaics into the system presents new possibilities for building-integrated photovoltaics by combining adaptive shading capabilities with facade-integrated solar tracking. This innovation not only reduces the building's energy demand but also facilitates onsite electricity generation [158, 159]. Figure 13 shows an example of adaptive solar facade [160].

4.6. The Kiefer Technic Showroom

The adaptive facades significantly contribute to occupant well-being by optimizing indoor comfort through effective regulation of daylight, temperature, and external views. Kiefer Technic Showroom in Bad Gleichenberg, Austria illustrates how adaptive facades can create healthier and more pleasant indoor environments by dynamically adjusting to environmental conditions [161, 162]. The Kiefer Technic Showroom is an exemplary model of modern adaptive facade technology, designed by Giselsbrecht + Partners [163].

The Kiefer technic was completed in 2007, which is recognized for its innovative approach to managing environmental conditions and enhancing energy efficiency through a dynamic facade system. The primary concept of the Kiefer Technic Showroom is to create a building that adapts seamlessly to its surrounding environment, embodying the idea of a "breathing facade". The exterior is covered with motorized aluminum panels, designed to move and adjust throughout the day in response to changing light and temperature conditions [164].

The structure not only serves as a functional space for showcasing medical furniture but also acts as a living advertisement for the company's commitment to innovation and technological integration in architecture.

The standout feature of the Kiefer Technic Showroom is its adaptive facade, composed of 112 individual panels that can be controlled independently. These panels are mounted on a track system, allowing them to slide open or closed based on real-time data from sensors that monitor sunlight, temperature, and wind conditions. The movement of these panels is powered by a centralized control system that automatically adjusts their positioning to optimize the building's energy performance. For instance, on hot, sunny days, the panels close to provide shade, reducing solar heat gain and minimizing the need for air conditioning. Conversely, during cooler or overcast days, the panels open to maximize natural light, reducing the dependence on artificial lighting and utilizing passive solar heating. This ability to adapt in real-time helps maintain a comfortable indoor climate while significantly improving the building's energy efficiency.



Figure 14.
Kiefer Technic Showroom's dynamic facade system [162].

The automation system of the Kiefer Technic Showroom is designed to balance automated control with user flexibility. The building is equipped with an intelligent BMS that processes data from external environmental sensors and adjusts the facade panels accordingly. However, occupants also have the option to manually override the system using wall-mounted controls inside the building. This dual mode of operation ensures that the facade not only optimizes energy use but also meets the comfort preferences of users, enhancing the overall occupant experience. The adaptive facade of the Kiefer Technic Showroom plays a crucial role in reducing the building's energy consumption. By dynamically managing solar gain and optimizing natural light, the system helps lower cooling and heating loads throughout the year. Studies have indicated that the dynamic facade reduces the building's energy consumption for cooling by up to 30%, making it significantly more efficient than traditional static facades. The Kiefer Technic Showroom has received widespread acclaim for its forward-thinking design and contribution to sustainable architecture. Figure 14 shows an example of Kiefer Technic Showroom's dynamic facade system.

4.7. The Pearl River Tower

The Pearl River Tower in Guangzhou, China, stands as a benchmark in sustainable skyscraper design, seamlessly blending innovative engineering with environmental responsibility [165]. Completed in 2011, this structure exemplifies how modern architecture can harmonize efficiency and elegance. Its streamlined design minimizes wind resistance, while incorporating a suite of green technologies that enhance performance and reduce its carbon footprint. The Pearl River Tower was strategically reoriented away from Guangzhou's main power grid to harness wind energy effectively. Its broad face was positioned perpendicular to the prevailing southerly winds, which blow consistently for approximately 80% of the year, creating an ideal scenario for wind energy generation. However, this orientation also resulted in increased structural demands, as Guangzhou's coastal location subjects it to significant wind activity.

The Pearl River Tower is considered an example of adaptive facades that presents an innovative opportunity to integrate energy generation systems toward sustainability [166]. The Pearl River Tower has been designed to incorporate hydrogen fuel cells within its facade system, aiming to store surplus energy generated by the building. This advanced technology enables the conversion of hydrogen gas into electricity with an impressive energy efficiency exceeding 50%. The resulting power can then be efficiently utilized to support the building's cooling and ventilation systems, contributing to both energy conservation and reduced reliance on conventional power sources. This integration of hydrogen fuel cells exemplifies a forward-thinking approach to sustainable design, positioning the Pearl

River Tower as a leader in environmentally adaptive building solutions [167, 103]. Figure 15 shows and example of the Pearl River Tower in Guangzhou, China [168, 103].



Figure 15.
The Pearl River Tower in Guangzhou, China [168, 103].



Figure 16.
Henning Larsen's dynamic façade [103, 170].

4.8. Henning Larsen's University Building

The Henning Larsen's University Building/SDU Campus Kolding in the University of Southern Denmark exemplifies the innovative use of dynamic facade design, incorporating adaptable patterns that respond to changing environmental conditions [169, 15]. These kinetic patterns are achieved through

carefully engineered facade elements, such as movable panels and light-filtering materials, which adjust based on sunlight exposure and temperature variations [169]. This dynamic approach not only enhances energy efficiency by optimizing solar shading and natural lighting but also enriches the aesthetic appeal of the building, creating a visually engaging facade that evolves throughout the day. Moreover, the adaptability of the facade reduces reliance on artificial lighting and HVAC systems, promoting a more sustainable indoor environment and enhancing occupant comfort by moderating interior temperatures and glare. The example of Henning Larsen's work illustrates how dynamic facades can balance functional benefits with striking architectural design, facilitating for more responsive and energy-efficient buildings in the future. Figure 16 shows a Henning Larsen's dynamic facade. The photo is taken by Hufton & Crow [103, 170].

4.9. The Al Bahr Towers

The design of Al Bahr Towers in United Arab Emirates (UAE) draws inspiration from traditional Islamic architecture, specifically the mashrabiya, a wooden lattice screen used historically to provide privacy while controlling light and ventilation [171]. The Al Bahr Towers are renowned for their innovative design, which blends modern technology with traditional architectural principles. One of the most striking features of the towers is their dynamic facade, inspired by the mashrabiya. The towers feature a unique honeycomb-like structure with an automated solar shading system, intended to enhance environmental performance. This adaptive facade is designed to respond dynamically to the harsh climate of Abu Dhabi in UAE by reducing solar gain and glare while allowing natural light into the interior. The kinetic shading devices are integrated into the towers' glass curtain wall, serving as a contemporary reinterpretation of traditional elements, merging aesthetic appeal with functional energy efficiency. The facade of Al Bahr Towers incorporates advanced automation technologies to adapt to changing environmental conditions. The dynamic shading system is controlled by a centralized BMS that uses sun-tracking software to adjust the shading devices in real-time according to the sun's position. The shading elements consist of triangular units that can open and close throughout the day, responding to various factors such as sunlight intensity, cloud cover, and wind speed. This automated response mechanism ensures optimal solar control, reducing the need for artificial cooling while enhancing occupant comfort. Additionally, sensors integrated into the facade provide continuous feedback to the control system, allowing it to override automatic settings during adverse weather conditions.

This adaptive shading system responds to the movement of the sun, opening and closing to control the amount of light and heat entering the building. By adjusting throughout the day, it significantly reduces solar gain, thus enhancing energy efficiency and reducing the need for air conditioning. This blend of cultural heritage and cutting-edge technology showcases how traditional design elements can be reimagined for modern sustainability [172]. Al Bahr Towers in Abu Dhabi is a 150-meter-height double tower featuring a beehive-inspired structure and a dynamic, automated solar screen that responds to the movement of the sun [15]. These solar screens respond dynamically and automatically to the angle of the sun, improving control of energy consumption, solar radiation, and glare while being able to allow natural light into the building. The building consists of two circular towers 150 meters high clad with a curtain wall covered with a kinetic shading system. The tower floor is open-plan office space with a service center. Furthermore, this design is expected to reduce the solar radiation entering the building by 20%, so that the CO₂ emissions could be reduced by 40% [103]. In addition it can achieve a gain in solar heat by 50% [100].

The dynamic shading system is a screen made up of triangular modules like origami umbrellas. The triangular units act as individual shading devices that unfold at different angles in response to the movement of the sun in order to block direct solar radiation [172]. The design idea of the building combines the design idea of the shading system of flowers that open and close in response to weather changes, and the idea of hexagonal shapes of Mashrabiya in Islamic architecture. Noting that Mashrabiya is an architectural feature commonly found in traditional Islamic architecture and beyond.

This element consists of a projecting oriel window, typically situated on the upper floors of a building and enclosed with intricately carved wooden latticework. At times, it is further adorned with stained glass for added visual appeal. Figure 17 shows a set of fully open shading devices photo courtesy taken by Terry Boake [172]. The building consists of two facades, the outer facade is two meters away from the inner facade - which consists of a glass wall. The external facade consists of (2000) umbrella-like units (1000 units per tower) that respond to direct rays automatically, as this system is considered a 50% heat saving and reduces energy consumption in the building. In particular, these intricate latticework windows provide shade and promote airflow, reducing the need for artificial cooling by allowing natural ventilation while blocking direct sunlight.

The structure of the Mashrabiya helps in maintaining a cooler indoor temperature, especially in hot climates, effectively lowering energy consumption by minimizing the reliance on mechanical cooling systems. In addition, the design of Mashrabiya preserves privacy without obstructing views, enhancing both comfort and functionality in buildings.



Figure 17.
A set of fully open shading devices [172].



Figure 18.
One Ocean Pavilion in South Korea [175].

4.10. One Ocean Pavilion

The One Ocean Pavilion, located in Yeosu, South Korea, is a striking example of sustainable architectural design. This architectural is designed as a part of Expo 2012, which focused on the theme "The Living Ocean and Coast". This design embodies principles of environmental awareness and technological innovation [173]. One of the key features of the One Ocean Pavilion is its dynamic facade, which adapts to environmental conditions to optimize energy efficiency and occupant comfort [151]. In particular, pavilion design utilizes advanced materials and shading systems to reduce heat gain while allowing natural light to permeate interior spaces. This approach minimizes reliance on artificial lighting and cooling systems, contributing to a lower overall energy footprint [174]. Moreover, the structure of Pavilion is equipped with renewable energy technologies, including solar panels and systems for harnessing ocean energy. Such design not only generates power for the building's operations but also showcases the potential of clean energy solutions in modern construction.

The One Ocean Pavilion exemplifies how architecture can align with sustainability goals, offering a forward-thinking model for buildings in coastal and marine environments. By combining cutting-edge technology with a commitment to ecological preservation, it stands as a testament to innovative and responsible design. Figure 18 shows picture of One Ocean Pavilion in South Korea [175].

5. Advancements in Adaptive Facades

The Modern designs hold the potential to revolutionize the future of sustainable and intelligent architecture by introducing advanced levels of responsiveness and efficiency into built environments. Unlike conventional approaches, which rely on static materials and predictable responses, modern designs enable buildings to dynamically interact with their surroundings through innovative, adaptive materials. These materials can adjust to variations in light, temperature, and other environmental factors, allowing for real-time adjustments that minimize energy consumption and enhance occupant comfort. Such adaptability not only reduces reliance on artificial heating, cooling, and lighting systems but also aligns seamlessly with the goals of smart, self-regulating building systems.

5.1. Improving Efficiency in Literature Searches

As architectural design moves towards intelligent systems that integrate seamlessly with environmental conditions, advancements in materials solutions offer a pathway to achieve high-performance buildings that are both ecologically responsible and technologically advanced. This

transformative approach redefines sustainable architecture, establishing a new paradigm where buildings actively contribute to environmental conservation while delivering optimized, user-centered experiences.

Recent advancements in materials are paving the way for innovative applications in adaptive architecture, promising to elevate both efficiency and responsiveness in building design [176]. Materials such as nanomaterials, smart glass, and responsive polymers, represent a new frontier in sustainable architectural design [177, 178, 179, 180]. Nanomaterials, for instance, possess unique properties at the nanoscale, allowing them to interact with energy and light in ways that conventional materials cannot [181]. Their high surface area and customizable structures make them ideal for capturing, storing, and even directing energy in ways that can be tailored to specific environmental needs. In building applications, nanomaterials can help regulate temperature and improve insulation, and thus, improving energy efficiency [182].

Materials can directly manipulate the energy flow without the need for mechanical parts, reducing energy loss and maintenance requirements [183]. Quantum materials can operate on a molecular level, hence adjusting to changes in the environment with greater speed and precision. Materials are essential in improving the efficiency of photovoltaic cells, which will result in more sustainable energy sources [55]. Advanced materials also include topological insulators, superconductors, and quantum dots, exhibit unique properties that enable them to manipulate energy and information at a level far beyond conventional materials [184]. Materials with variable transparency use quantum dot technology, which allows precise control over light transmission [185, 186]. These materials can dynamically adjust their transparency in response to external stimuli like sunlight, optimizing natural lighting while reducing energy consumption in buildings. Quantum dots, known for their tunable optical properties, have found applications in adaptive glazing technologies, allowing facades to dynamically adjust transparency levels in response to sunlight, thus optimizing natural lighting and reducing cooling demands. Quantum dots within the facade can selectively filter and manage different wavelengths of light, allowing optimal natural light penetration while blocking infrared radiation that causes heat gain [187]. This selective control improves thermal comfort and reduces the energy required for cooling. These advancements make it feasible to design facades and interior materials that respond actively to environmental conditions, enabling buildings to self-regulate and maintain optimal energy states. As research progresses, the integration of advanced materials into architecture may yield structures that not only adapt intelligently to their surroundings but also contribute to reducing the environmental footprint of urban spaces, signaling a major breakthrough in sustainable architectural practices.

Furthermore, the facades can achieve higher efficiency in converting solar energy into electricity compared to traditional systems [188]. This means more energy can be harvested even in low-light conditions, further reducing the building's reliance on non-renewable energy sources. Furthermore, with an enhanced energy efficiency, adaptive facades contribute to lower CO₂ emissions [189]. By reducing the demand for external energy and minimizing the usage of fossil fuels, these systems help decrease the overall carbon footprint of the building throughout its lifecycle. For instance, quantum dot luminescent solar concentrators (QDL-SCs) can be incorporated into building glazing, offering semi-transparent photovoltaic solutions that generate energy while admitting natural light and enabling visible light communication for smart connectivity [190]. The applications of smart glazing techniques optimize indoor conditions while minimizing energy use [191, 5]. Similarly, integrating photovoltaic cells into architectural elements like roofs and facades supports efficient energy generation, reducing dependency on external sources and addressing energy demands in public buildings [192]. Additionally, multiscale design principles optimize energy generation, water regeneration, and waste processing within buildings, enabling self-sufficiency and reducing environmental impact [193].

Smart material-driven adaptive facades represent an innovative approach to sustainable design, functioning with minimal or even zero operational energy input. Notable examples include systems like HygroSkin and Bloom, which leverage the intrinsic properties of their materials to adapt dynamically to environmental changes. In addition, wind-responsive designs provide another energy efficient solution

by utilizing natural forces to regulate building performance. These advancements showcase the potential of adaptive facades to contribute significantly to energy-conscious architecture [194, 148, 103, 195].

Smart glass, another promising material, uses advanced technology to alter its transparency in response to sunlight [196]. This adaptability helps regulate natural lighting and heat within a building, optimizing interior comfort while reducing energy consumption [197]. By adjusting its opacity, smart glass can effectively manage the inflow of solar energy, reducing the need for artificial lighting and air conditioning. The application of smart glass can also be in windows so that enables smart window technologies. Advanced smart window technologies leverage materials that enable passive cooling by reflecting infrared radiation while permitting visible light transmission. In addition, modern smart window technologies offer comprehensive year-round thermal regulation by integrating both passive cooling and heating functions. This innovation significantly reduces dependence on fossil fuels for indoor climate control [198]. For example, the work in [199] highlighted the development of smart windows using polymer-dispersed liquid crystal films, achieving a radiative cooling efficiency of 142.69 W/m², thereby effectively maintaining indoor thermal comfort. The incorporation of thermotropic materials into window designs could also offers dynamic control over solar energy transmission. Research demonstrated that a Thermotropic Parallel Slat Transparent Insulation Material (TT PS-TIM) system significantly reduced solar heat gain—by more than 30% during summer and 20% in winter—when compared to traditional systems [200].

Responsive polymers are also transforming building design by reacting to changes in their environment, such as temperature, moisture, or light [201]. These polymers can expand, contract, or change properties, making them ideal for dynamic facades that respond to environmental shifts. Furthermore, the exploration of novel materials and cutting-edge technologies is central to maximizing the effectiveness of quantum potential energy in adaptive facades, promising transformative possibilities in sustainable building design. Materials such as graphene, perovskites, and phase change materials are at the forefront of this innovation due to their unique properties that align well with quantum energy applications [202, 203, 204, 205, 206]. Graphene, celebrated for its remarkable conductivity and strength at the atomic level, could enable facades to harness and regulate energy flows efficiently, adapting in real time to environmental changes [207, 208]. Shape memory polymers (SMP) are innovative materials capable of altering their shape in response to temperature changes, making them ideal for thermally adaptive facades. By using SMP actuators, facades can dynamically adjust shading based on solar radiation and air temperature, effectively reducing heat gain and enhancing indoor comfort [209]. Similarly, Vacuum-Photovoltaic-Thermoelectric (VPT) glazing integrates thermal insulation, energy generation, and climate control to optimize heat transfer year-round. This technology has been shown to lower air-conditioning energy consumption by approximately 55%, demonstrating its potential for energy-efficient building applications.

The work in [210] discussed adaptive facade materials that utilize solid-solid phase change materials (SS-PCM) with variable transparency, specifically focusing on enhancing energy efficiency in building enclosures through passive thermal control. To this end, two innovative facade systems are examined. Reflective properties in quantum-inspired materials can be achieved through thin-film coatings and nanostructured surfaces that manipulate light on the quantum scale [211, 212, 213, 214, 215]. These coatings can adjust reflectivity based on ambient conditions, helping manage heat and glare by reflecting or absorbing specific wavelengths of light. Such adaptive properties are essential in creating energy-efficient facades that respond to changing light conditions throughout the day. The work in [5] discussed several types of coating techniques that are used in the manufacturing of functional coatings. These types include spray coating, dip coating, spin coating, and roll-to-roll processing.

Certain materials possess the ability to detect and respond to environmental changes. Structural adaptability emerges from quantum-inspired materials like shape memory alloys and responsive polymers [79, 80, 81]. For example, shape memory alloys can alter their form in response to

temperature shifts, enabling kinetic facade systems that operate without requiring external energy inputs [216]. These materials exhibit flexibility and can change their form or rigidity in response to temperature, pressure, or electrical stimuli. This adaptability is invaluable in creating facades that can modify their shape or structural properties, enhancing both functionality and resilience to external conditions. Together, these technologies embody the integration of quantum mechanics in material science, supporting the development of intelligent, sustainable architectural designs.

Adaptive facades incorporate biomimicry by emulating natural thermoregulation mechanisms, such as the insulating and cooling properties observed in animal fur and skin [217, 218]. Specifically, drawing inspiration from nature, architects can design facades that emulate adaptive features found in organisms, such as the textured and morphologically optimized skin of elephants, which enhances cooling efficiency [219]. Smart materials establish a responsive interface between buildings and their surroundings, efficiently regulating temperature and managing solar radiation [179]. By incorporating materials that passively adapt to external conditions, buildings can achieve substantial energy savings while enhancing indoor environmental quality [220].

5.2. Energy Efficiency and Sustainability Benefits with Building Facades

Quantum energy systems represent an emerging technology with the potential to transform the way building facades manage and optimize energy [221]. By integrating quantum properties into facade design, these systems can significantly reduce energy consumption and minimize the carbon footprint of buildings [222, 223]. When applied to building facades, these systems can enhance energy absorption, distribution, and utilization. One key approach involves using quantum dots or nanomaterials that can convert sunlight into usable energy more efficiently than traditional solar panels. These materials can be embedded in the facade, enabling it to act as a semi-transparent solar collector that not only reduces the building's dependency on external energy sources but also decreases heat gain, thereby lowering cooling demands.

Traditional energy-efficient facades primarily aim to enhance thermal resistance, thereby minimizing conductive heat transfer between indoor and outdoor environments. Recently, there has been growing interest in optimizing heat transfer via electromagnetic radiation by regulating the solar irradiation properties of facades [224, 225] and their thermal emission characteristics [226, 227]. In comparison to traditional adaptive systems, which may rely on mechanical adjustments (like shades or louvers) to control light and temperature, quantum adaptive facades offer several advantages, such as higher efficiency, enhanced light control, improved solar energy conversion, and reduction of carbon footprint.

Implementing quantum based adaptive facades has the potential to significantly reduce energy consumption and a building's environmental impact [15]. This integration could significantly reduce dependence on HVAC and artificial lighting systems by efficiently managing solar gain, ventilation, and natural daylight. Through dynamic adjustments to external conditions, these facades optimize energy performance within the building, contributing to a more sustainable and comfortable indoor environment. By harnessing passive solar heat, maximizing natural ventilation, and enhancing daylight distribution, adaptive facades help lower energy consumption and operational costs while supporting occupant comfort and wellbeing [110].

5.3. Impact of Adaptive Facades on Building Comfort and Usability

Adaptive facades hold transformative potential for enhancing building comfort and usability by allowing structures to engage with energy flows at a microscopic level. By incorporating materials and technologies, buildings can better regulate temperature, light, and overall indoor conditions, adapting to environmental shifts in real time. This heightened level of adaptability creates spaces that automatically respond to the occupants' needs, resulting in a more comfortable, consistent interior climate with minimized energy input. For instance, advanced materials in walls or windows might interact with heat and light at a molecular level, reducing the need for artificial heating and cooling. This capability not

only fosters a more sustainable use of resources but also elevates the overall usability of the space, as occupants experience stable and comfortable surroundings tailored to natural changes in the environment.

Incorporating quantum energy systems within buildings has the potential to significantly improve occupant comfort, lighting, temperature control, and usability. Inspired by the behavior of the *Gazania* flower, kinetic facades adjust to sunlight, achieving optimal daylight penetration of 87.5% to 100% while preventing issues like glare and overheating [228]. By leveraging parametric modeling, these systems enhance daylight performance, making them a key innovation in sustainable architecture. Smart glass can dynamically regulate light transmittance, ranging from 4% to 80%, effectively managing solar gain and reducing indoor overheating [229]. When paired with intelligent lighting systems, it maintains ideal illumination levels, significantly improving energy efficiency. Fluidic pigment modulation in adaptive facades enables precise shading adjustments, cutting energy costs by more than 30% compared to conventional methods [230]. This technology facilitates localized responses to solar variations, enhancing indoor comfort. Reinforcement learning can automate electrochromic glass control, achieving a 97% success rate in avoiding glare while optimizing daylight usage [231]. This innovation minimizes reliance on artificial lighting, ensuring greater visual comfort and energy savings.

Quantum energy applications support renewable energy utilization, such as solar panels and wind turbines, essential for lowering greenhouse gas emissions [232, 233]. Advanced materials like bio-concrete and self-healing composites further enhance sustainability by reducing the ecological impact of buildings [232]. Adaptive distributed technologies, such as solar envelopes, dynamically respond to environmental conditions, improving energy efficiency and occupant comfort [234, 235]. These systems also enable user interaction, offering personalized control over temperature and lighting to enhance satisfaction [235]. Smart technologies integrated into building designs enable real-time monitoring and efficient energy management, reducing operational costs and environmental impacts. Life cycle assessments confirm these approaches significantly boost building performance and sustainability [174].

5.4. *The Economic Implications of Adaptive Facades*

Implementing adaptive facades presents distinct economic implications compared to traditional systems, reflecting both initial investment and long-term operational benefits. Recent research has shown that optimizing building facades leads to significant improvements in economic, environmental, and social outcomes, see. e.g. [236, 237, 6, 203, 238]. Considering quantum energy in adaptive facades offers significant long-term savings by reducing energy consumption and operational costs. Quantum adaptive facades, with their ability to dynamically adjust to environmental conditions, minimize the need for artificial heating, cooling, and lighting, thus lowering ongoing energy expenses. Moreover, quantum facades enhance building longevity and resilience by using materials that require less maintenance and repair, further lowering lifecycle costs.

The incorporation of intelligent facade layers (IFL) has proven essential in various landmark architectural projects, benefiting both new constructions and retrofitting efforts [237, 6]. Particularly, the work in [237] highlighted that HVAC, lighting, appliances, and general building services collectively consume around 97.6% of a building's energy, of which facade optimization alone can reduce up to 36%. Furthermore, utilizing advanced building envelopes integrated with phase-change materials (PCMs), photovoltaic systems, and thermoelectric components can further decrease overall energy demand by 20–50% [202]. In regions with extreme heat, maintaining indoor comfort while reducing energy use is a major challenge [238].

5.5. *Integrating of Advanced Technologies with Smart Building*

One Integrating traditional design elements with contemporary materials facilitates the creation of facades that are culturally significant and technologically innovative, fostering sustainability [239, 240]. For example, the integration of quantum energy facades into smart building systems can be done

by using advanced AI algorithms and IoT frameworks to optimize energy management. This approach aligns with the current trends in architectural design, which focus on enhancing building efficiency and sustainability by leveraging advanced technologies.

The implementation of IoT devices, such as sensors and smart controllers, facilitates continuous monitoring of environmental conditions and energy usage patterns in facades design.

In addition, insights from IoT sensors can help regulate HVAC and lighting systems, adjusting them based on real-time data from the facades [232]. This reduces the load on traditional energy systems and promotes a more sustainable building environment. By connecting these facades to smart grids, buildings can participate in demand response strategies, optimizing energy use based on grid conditions and renewable energy availability. Ultimately, this synergy not only improves energy efficiency but also supports the development of sustainable, low-carbon buildings, aligning with global efforts to reduce greenhouse gas emissions and enhance energy independence. As such, this would indeed contribute [241]. The integration of artificial intelligence (AI) within architectural design is profoundly transforming how buildings are conceptualized, optimized, and constructed [242]. AI algorithms can be used to analyze the vast amounts of data generated by IoT devices to predict and optimize energy usage patterns. To this end, machine learning models can forecast energy demand based on historical data, allowing the quantum facades to adjust proactively. This predictive capability helps in reducing energy wastage and improves the operational efficiency of the smart building systems. The role of AI in design processes, particularly in conjunction with advanced technologies like Building Information Modeling (BIM), enhances real-time analysis and optimization, which leads to better decision-making and efficiency improvements [242].

The work in [243] presented a framework for integrating AI, BIM, and IoT to optimize energy management in smart, sustainable building systems. The paper discussed that by connecting IoT data with AI through BIM, buildings can achieve continuous, responsive adaptation of energy consumption patterns. BIM models could simulate facade performance under various conditions, allowing AI algorithms to analyze and predict optimal energy usage strategies. Besides, the use of IoT sensors that are placed throughout the building feed live data back into BIM models, helping AI refine predictions and make real-time adjustments in response to environmental changes. AI analyzes IoT sensor data to anticipate maintenance needs and optimize energy usage, hence enhancing overall efficiency and sustainability.

The integration of quantum energy facades with IoT and smart building technologies offers a dynamic approach to optimizing energy management in modern constructions. Quantum energy facades are designed to capture solar energy efficiently, and when combined with IoT devices, they can adapt to real-time environmental conditions. Sensors collect data on sunlight intensity, temperature, and energy demand, enabling the facades to adjust their energy output dynamically. This adaptive control helps align energy production with immediate building needs, reducing waste and improving efficiency. Additionally, incorporating AI algorithms allows for predictive analysis, where the system anticipates changes in energy demand and adjusts the facade's performance accordingly, hence minimizing energy costs and enhancing sustainability.

The work in [244] investigated the integration of IoT and AI in sustainable building designs, which could be used in optimizing energy management for smart buildings. The paper discussed that the IoT sensors can be used to provide continuous data on environmental conditions (e.g., temperature, lighting), feeding this information into AI systems that optimize energy usage and adjust facades based on real-time demands. This dynamic control enhances building efficiency and reduces unnecessary energy consumption. AI systems analyze data from IoT sensors to control energy-efficient features, such as HVAC and lighting, by predicting needs and adjusting operations proactively. This reduces manual intervention, aligns with smart energy goals, and could effectively support quantum facade technologies that adapt to external and internal changes. IoT and AI contribute to a balanced indoor climate by automatically adjusting to occupancy patterns and environmental shifts. This automation supports energy conservation while maintaining comfort, a vital aspect of smart facades that respond to

building needs.

The work in [56] discussed that AI and machine learning algorithms can be efficiently exploited in optimizing responsive facade systems to enhance multiple performance parameters. These parameters include illuminance levels, lighting energy consumption, visual discomfort from solar glare, solar heat gain, thermal resistance (influencing heating energy and comfort), and natural ventilation.

The work in [242] highlighted the evolving nature of architectural design education and practice, where AI tools are seen as essential in streamlining work-flows, fostering creativity, and improving sustainability. A key focus of the paper was the shift towards using generative AI algorithms and machine learning to explore multiple design options rapidly, enabling architects to make data-driven choices that align with environmental and structural needs. By integrating AI with smart building technologies, designers can enhance the building's energy efficiency and overall performance. The use of digital twins and IoT sensors allows for continuous data collection, providing insights into building behavior under various conditions. This capability supports predictive maintenance and energy optimization, which are critical for the development of sustainable and adaptive buildings. Ultimately, the paper demonstrated that incorporating AI in design education can help future architects master these technologies, equipping them with the skills to innovate and respond to the growing demand for sustainable and efficient building solutions. The study's findings suggest that as AI technologies continue to advance, their integration into architecture will become increasingly vital, providing powerful tools for enhancing creativity, efficiency, and sustainability in the built environment.

The work in [245] investigated the integration of IoT on smart facades and implementing the digital twin concept in kinetic facades to advance the field of intelligent buildings and sustainable lean architecture. This paper explored advancements in climate-responsive building envelopes, focusing on automatically adjustable kinetic facades equipped with real-time solar tracking systems, as well as sensors for temperature, humidity, occupancy, and air quality monitoring. Furthermore, this paper examined how real-time adaptability can be exploited in facade design to respond effectively to dynamic environmental conditions.

The work in [56] focused on a real-time adaptive Building Integrated Photovoltaic (BIPV) shading system, evaluating its performance in terms of energy generation and visual comfort compared to conventional static BIPV systems.

6. Conclusion and Future Works

This paper discussed the adaptive facades that not only respond to environmental changes but also enhance energy efficiency and occupant comfort. To this end, the paper focused on understanding how advanced technologies can be applied in designing adaptive facades that respond dynamically to environmental conditions. The paper provided a framework for future innovations in smart and sustainable architecture. Some practical examples have been provided and explained, which underscore the potential of adaptive facades to revolutionize building designs in terms of functionality, adaptability, and environmental responsibility. Several case studies have been provided to illustrate the practical application of adaptive facades. Furthermore, the paper discussed that the integration of IoT and AI technologies in facade design represents a transformative approach to creating adaptive, energy-efficient, and sustainable buildings. IoT-enabled sensors and smart controllers facilitate continuous monitoring of environmental conditions, such as temperature, lighting, and occupancy, enabling facades to dynamically respond to real-time data. By optimizing energy output—maximizing energy harvesting during peak sunlight and minimizing wastage during low-demand periods—these systems significantly enhance overall energy efficiency while reducing carbon footprints. Moreover, AI algorithms can analyze vast data sets to predict and optimize energy usage patterns, allowing facades to proactively adjust to changing conditions. This supports advanced energy management strategies, including demand response through smart grid connections and automated regulation of HVAC and lighting systems. By reducing manual intervention and aligning operations with sustainability goals, AI enables smart facades to achieve a balanced indoor climate and operational efficiency. These advancements not

only lower energy costs but also contribute to the global pursuit of sustainable, low-carbon building practices, underscoring their essential role in the future of architectural design. Therefore, taking the advantage of the powerful AI and machine learning algorithms could enable facades to adjust based on anticipated climate changes and energy demands.

Future work in the field of architecture should focus on exploring its potential, as advancements in materials science and engineering continue to drive innovation. Ongoing research and future breakthroughs are expected to significantly enhance its capabilities and open new possibilities for practical applications. Future work could include further advancements in material science and quantum theory applications that is helpful in optimizing the performance and scalability of the architectural design. Future work could also explore the integration of advanced materials and adaptive mechanisms. This could include investigating nanomaterials with dynamic properties that respond to environmental stimuli, such as temperature and light intensity. This in terms would enhance the facade's ability to modulate energy exchange in real-time. Future research could also include the application of AI to optimize facade adaptability, hence allowing the application of fast and efficient algorithms for energy modulation in large-scale architectural designs.

Transparency:

The authors confirm that the manuscript is an honest, accurate, and transparent account of the study; that no vital features of the study have been omitted; and that any discrepancies from the study as planned have been explained. This study followed all ethical practices during writing.

Copyright:

© 2025 by the authors. This open-access article is distributed under the terms and conditions of the Creative Commons Attribution (CC BY) license (<https://creativecommons.org/licenses/by/4.0/>).

References

- [1] N. Adamo, N. Al-Ansari, and V. Sissakian, "Review of climate change impacts on human environment: Past, present and future projections," *Engineering*, vol. 13, no. 11, pp. 605–630, 2021. <https://doi.org/10.4236/eng.2021.1311044>
- [2] A. Pandey and M. Asif, "Assessment of energy and environmental sustainability in south asia in the perspective of the sustainable development goals," *Renewable and Sustainable Energy Reviews*, vol. 165, p. 112492, 2022. <https://doi.org/10.1016/j.rser.2022.112492>
- [3] D. Marazziti, P. Cianconi, F. Mucci, L. Foresi, I. Chiarantini, and A. Della Vecchia, "Climate change, environment pollution, covid-19 pandemic and mental health," *Science of the Total Environment*, vol. 773, p. 145182, 2021. <https://doi.org/10.1016/j.scitotenv.2021.145182>
- [4] X. Ren, J. Li, F. He, and B. Lucey, "Impact of climate policy uncertainty on traditional energy and green markets: Evidence from time-varying granger tests," *Renewable and Sustainable Energy Reviews*, vol. 173, p. 113058, 2023. <https://doi.org/10.1016/j.rser.2022.113058>
- [5] G. Wang, K. Ryu, Z. Dong, Y. Hu, Y. Ke, Z. Dong, and Y. Long, "Micro/nanofabrication of heat management materials for energy-efficient building facades," *Microsystems & Nanoengineering*, vol. 10, no. 1, p. 115, 2024. <https://doi.org/10.1038/s41378-024-00744-y>
- [6] M. Salihi, M. El Fiti, Y. Harmen, Y. Chhiti, A. Chebak, F. E. M. Alaoui, M. Achak, F. Bentiss, and C. Jama, "Evaluation of global energy performance of building walls integrating pcm: Numerical study in semi-arid climate in morocco," *Case Studies in Construction Materials*, vol. 16, p. e00979, 2022. <https://doi.org/10.1016/j.cscm.2022.e00979>
- [7] B. Ghaleb and M. Asif, "Application of solar pv in commercial buildings: Utilizability of rooftops," *Energy and Buildings*, vol. 257, p. 111774, 2022. <https://doi.org/10.1016/j.enbuild.2021.111774>
- [8] F. Ascione, N. Bianco, T. Iovane, M. Mastellone, and G. M. Mauro, "The evolution of building energy retrofit via double-skin and responsive facades: A review," *Solar Energy*, vol. 224, pp. 703–717, 2021. <https://doi.org/10.1016/j.solener.2021.06.035>
- [9] P. Mercader-Moyano, P. Anaya-Durán, and A. Romero-Cortés, "Eco-efficient ventilated facades based on circular economy for residential buildings as an improvement of energy conditions," *Energies*, vol. 14, no. 21, p. 7266, 2021. <https://doi.org/10.3390/en14217266>
- [10] U. Berardi, "A cross-country comparison of the building energy consumptions and their trends," *Resources, Conservation and Recycling*, vol. 123, pp. 230–241, 2017. <https://doi.org/10.1016/j.resconrec.2016.03.014>
- [11] A. Nutkiewicz, B. Choi, and R. K. Jain, "Exploring the influence of urban context on building energy retrofit performance:

- A hybrid simulation and data-driven approach,” *Advances in Applied Energy*, vol. 3, p. 100038, 2021. <https://doi.org/10.1016/j.adapen.2021.100038>
- [12] H. Li, Z. Wang, T. Hong, and M. A. Piette, “Energy flexibility of residential buildings: A systematic review of characterization and quantification methods and applications,” *Advances in Applied Energy*, vol. 3, p. 100054, 2021. <https://doi.org/10.1016/j.adapen.2021.100054>
- [13] M.-J. Kim, B.-g. Kim, J.-s. Koh, and H. Yi, “Flexural biomimetic responsive building facade using a hybrid soft robot actuator and fabric membrane,” *Automation in Construction*, vol. 145, p. 104660, 2023. <https://doi.org/10.1016/j.autcon.2022.104660>
- [14] C. Bedon, M. Kozłowski, M. Stepinac, and A. Haddad, *Facade Design: Challenges and Future Perspective*. BoD—Books on Demand, 2024.
- [15] G. Jamilu, A. Abdou, and M. Asif, “Dynamic facades for sustainable buildings: A review of classification, applications, prospects and challenges,” *Energy Reports*, vol. 11, pp. 5999–6014, 2024. <https://doi.org/10.1016/j.egy.2024.05.047>
- [16] A. M. Faragalla and S. Asadi, “Biomimetic design for adaptive building facades: A paradigm shift towards environmentally conscious architecture,” *Energies*, vol. 15, no. 15, p. 5390, 2022. <https://doi.org/10.3390/en15155390>
- [17] A. Abbas, “The advantages and challenges of smart facades toward contemporary sustainable architecture,” *Journal of Engineering Research*, vol. 7, no. 4, pp. 127–145, 2023. <https://doi.org/10.21608/erjeng.2023.325573>
- [18] K. K. Abdig'aniyevich, “The concept of a quantum and its physical meaning,” *Galaxy International Interdisciplinary Research Journal*, vol. 9, no. 10, 2021.
- [19] D. Pastorello, “Basics of quantum mechanics,” in *Concise Guide to Quantum Machine Learning*. Springer, 2023, pp. 7–23.
- [20] D. Bohm, *Quantum theory*. Courier Corporation, 1989.
- [21] A. Peres, *Quantum theory: Concepts and methods*, Springer, 1997, vol. 72.
- [22] R. Golub, S. K. Lamoreaux, and S. Lamoreaux, *The historical and physical foundations of quantum mechanics*. Oxford University Press, 2023.
- [23] R. Cheng, “[retracted] description of quantum mechanics as a branch of mathematical physics that deals with the emission and absorption of energy by matter,” *Security and Communication Networks*, vol. 2022, no. 1, p. 4293800, 2022. <https://doi.org/10.1155/2023/9846362>
- [24] A. Messiah, *Quantum mechanics*, Courier Corporation, 2014.
- [25] O. Matsuoka, “A compact derivation of quantum potential in de broglie–bohm theory,” *Journal of the Physical Society of Japan*, vol. 92, no. 2, p. 024002, 2023. <https://doi.org/10.7566/jpsj.92.024002>
- [26] A. Lipovka, “Nature of the quantum potential,” *arXiv preprint arXiv:1603.01642*, 2016.
- [27] C. Ferreira, J. Barreiras, A. Silva, J. de Brito, I. S. Dias, and I. Flores-Colen, “Impact of environmental exposure conditions on the maintenance of facades’ claddings,” *Buildings*, vol. 11, no. 4, p. 138, 2021. <https://doi.org/10.3390/buildings11040138>
- [28] M. N. Charkas, “Towards environmentally responsive architecture: A framework for biomimic design of building’s skin,” *Journal of Engineering Sciences*, vol. 47, no. 3, pp. 371–388, 2019. <https://doi.org/10.21608/jesaun.2019.115486>
- [29] D. Huang, C. O. Delang, Y. Wu, and S. Li, “An improved lotka–volterra model using quantum game theory,” *Mathematics*, vol. 9, no. 18, p. 2217, 2021. <https://doi.org/10.3390/math9182217>
- [30] I. Joseph, “Koopman–von neumann approach to quantum simulation of nonlinear classical dynamics,” *Physical Review Research*, vol. 2, no. 4, p. 043102, 2020. <https://doi.org/10.1103/physrevresearch.2.043102>
- [31] T. Hübsch, D. Minic, K. Nikolic, and S. Pajevic, “On the emergent “quantum” theory in complex adaptive systems,” *Annals of Physics*, vol. 464, p. 169641, 2024. <https://doi.org/10.2139/ssrn.4660789>
- [32] T. Ando, M. Asano, A. Khrennikov, T. Matsuoka, and I. Yamato, “Adaptive dynamics simulation of interference phenomenon for physical and biological systems,” *Entropy*, vol. 25, no. 11, p. 1487, 2023. <https://doi.org/10.3390/e25111487>
- [33] D. Valente, F. Brito, and T. Werlang, “Quantum dissipative adaptation,” *Communications Physics*, vol. 4, no. 1, p. 11, 2021. <https://doi.org/10.1038/s42005-020-00512-0>
- [34] W. Stephenson, “William james, niels bohr, and complementarity: I—concepts,” *The Psychological Record*, vol. 36, pp. 519–527, 1986. <https://doi.org/10.1007/bf03394970>
- [35] R. Blutner, “Complementarity and quantum cognition,” in *Consciousness Studies in Sciences and Humanities: Eastern and Western Perspectives*. Springer, 2024, pp. 241–258.
- [36] N. Pathania and T. Qureshi, “Characterization of two-particle interference by complementarity,” *Physical Review A*, vol. 106, no. 1, p. 012213, 2022. <https://doi.org/10.1103/physreva.106.012213>
- [37] I. Klimenko, E. Palkin, and L. Sharapova, “Bohr’s complementarity principle and management decision making,” in *International Scientific and Practical Conference Digital and Information Technologies in Economics and Management*, Springer, 2021, pp. 181–189.
- [38] D. M. Snyder, “Bohr borrowed james the psychologist’s “complementarity” for measurement in quantum mechanics: James’s original version works for quantum mechanics, bohr’s does not,” 2022.

- [39] V. Korniyak, “Complementarity in finite quantum mechanics and computer-aided computations of complementary observables,” *Programming and Computer Software*, vol. 49, no. 5, pp. 423–432, 2023. <https://doi.org/10.1134/s036176882302010x>
- [40] R. P. Crease and A. S. Goldhaber, *The quantum moment: How Planck, Bohr, Einstein, and Heisenberg taught us to love uncertainty*. WW Norton & Company, 2014.
- [41] H. Yamasaki, S. Morelli, M. Miethlinger, J. Bavaresco, N. Friis, and M. Huber, “Activation of genuine multipartite entanglement: Beyond the single-copy paradigm of entanglement characterisation,” *Quantum*, vol. 6, p. 695, 2022. <https://doi.org/10.22331/q-2022-04-25-695>
- [42] P. A. Hanle, “Indeterminacy before heisenberg: The case of franz exner and erwin schrödinger,” *Historical Studies in the Physical Sciences*, vol. 10, pp. 225–269, 1979. <https://doi.org/10.2307/27757391>
- [43] A. Oldofredi, “Unexpected quantum indeterminacy,” *European Journal for Philosophy of Science*, vol. 14, no. 1, p. 15, 2024. <https://doi.org/10.1007/s13194-024-00574-9>
- [44] M. Tessarotto and C. Cremaschini, “The heisenberg indeterminacy principle in the context of covariant quantum gravity,” *Entropy*, vol. 22, no. 11, p. 1209, 2020. <https://doi.org/10.3390/e22111209>
- [45] Q. Li, R. T. Smith, and S. Maher, “Instantaneous action at a distance and the principle of locality, a new proposal about their possible connection,” 2024.
- [46] Y. Maleki and M. Suhail Zubairy, “Revisiting wave–particle duality in bohr–einstein debate,” *AVS Quantum Science*, vol. 5, no. 3, p. 031401, 2023. <https://doi.org/10.1116/5.0148225>
- [47] H. Shaaban, *The Rationalist Tendency in the Philosophy of Contemporary Science*. Mansha’at al-Ma’arif, Alexandria, Egypt, 1998.
- [48] Z. Li, “Quantum physics: A better model to understand consciousness-related brain functions,” *Theoretical and Natural Science*, vol. 34, pp. 269–272, 2024. <https://doi.org/10.54254/2753-8818/34/20241123>
- [49] X. Kuang, S. Wu, Q. Ze, L. Yue, Y. Jin, S. M. Montgomery, F. Yang, H. J. Qi, and R. Zhao, “Magnetic dynamic polymers for modular assembling and reconfigurable morphing architectures,” *Advanced Materials*, vol. 33, no. 30, p. 2102113, 2021. <https://doi.org/10.1002/adma.202102113>
- [50] E. Grillo, M. Milardi, and F. Olivieri, “A review of innovative materials for the design of adaptive biomimetic facades,” in *International Conference on Urban Planning and Architectural Design for Sustainable Development*. Springer, 2022, pp. 249–259.
- [51] D. Aelenei, L. Aelenei, and C. P. Vieira, “Adaptive facade: Concept, applications, research questions,” *Energy Procedia*, vol. 91, pp. 269–275, 2016. <https://doi.org/10.1016/j.egypro.2016.06.218>
- [52] K. Kyoung-Hee and T. Alberto, “Integrated facades for building energy conservation,” in *2015 AASRI International Conference on Circuits and Systems (CAS 2015)*. Atlantis Press, 2015, pp. 125–128.
- [53] A. Körner, L. Born, A. Mader, R. Sachse, S. Saffarian, A. Westermeier, S. Poppinga, M. Bischoff, G. Gresser, M. Milwich *et al.*, “Flectofold—a biomimetic compliant shading device for complex free form facades,” *Smart Materials and Structures*, vol. 27, no. 1, p. 017001, 2017. <https://doi.org/10.1088/1361-665x/aa9c2f>
- [54] A. Ajagekar and F. You, “Quantum computing and quantum artificial intelligence for renewable and sustainable energy: A emerging prospect towards climate neutrality,” *Renewable and Sustainable Energy Reviews*, vol. 165, p. 112493, 2022. <https://doi.org/10.1016/j.rser.2022.112493>
- [55] Y. Du, S. Chou, and R.-W. Li, “Developing advanced quantum materials is key to promoting science and technology,” *Advanced Science*, vol. 11, no. 37, p. 2407326, 2024. <https://doi.org/10.1002/advs.202407326>
- [56] N. Biloría, M. Makki, and N. Abdollahzadeh, “Multi-performative facade systems: The case of real-time adaptive bipv shading systems to enhance energy generation potential and visual comfort,” *Frontiers in Built Environment*, vol. 9, p. 1119696, 2023.
- [57] M. Ibrahim, L. Bianco, O. Ibrahim, and E. Wurtz, “Low-emissivity coating coupled with aerogel-based plaster for walls’ internal surface application in buildings: Energy saving potential based on thermal comfort assessment,” *Journal of Building Engineering*, vol. 18, pp. 454–466, 2018. <https://doi.org/10.1016/j.jobee.2018.04.008>
- [58] L. Petriccione, F. Fulchir, and F. Chinellato, “Self-adapting facade systems: Experimentation regarding the exploitation of thermal dilation,” *Journal of Green Building*, vol. 15, no. 4, pp. 67–90, 2020. <https://doi.org/10.3992/jgb.15.4.67>
- [59] W. H. Jordan, “A quantum mechanical theory of architecture,” Ph.D. Dissertation, 1996.
- [60] D. Wallace, “Philosophy of quantum mechanics,” in *The Ashgate companion to Contemporary Philosophy of Physics*. Routledge, 2016, pp. 22–104.
- [61] K. Lee, “The interior experience of architecture: An emotional connection between space and the body,” *Buildings*, vol. 12, no. 3, p. 326, 2022. <https://doi.org/10.3390/buildings12030326>
- [62] M. Perttunen and J. Haverinen, “Measurements of earth’s magnetic field indoors,” Oct. 30 2014, uS Patent App. 13/871,612.
- [63] M. Le Bellac, *Quantum physics*, Cambridge University Press, 2011.
- [64] I. Miroshnik, V. Molchanov, and C. Malikova, “Research of interaction of background geo-magnetic radiation with

- architectural forms,” *World Applied Sciences Journal*, vol. 27, no. 2, pp. 216–223, 2013.
- [65] J. Moloney, A. Globa, and R. Wang, “Hybrid environmental-media facades,” *KnE Engineering*, pp. 190–196, 2017.
- [66] A. Shafaghath and A. Keyvanfar, “Dynamic facades design typologies, technologies, measurement techniques, and physical performances across thermal, optical, ventilation, and electricity generation outlooks,” *Renewable and Sustainable Energy Reviews*, vol. 167, p. 112647, 2022. <https://doi.org/10.1016/j.rser.2022.112647>
- [67] S. Grynning, N. Lolli, S. I. Wågø, and B. D. Risholt, “Solar shading in low energy office buildings—design strategy and user perception,” 2017.
- [68] A. Tabadkani, S. Banihashemi, and M. R. Hosseini, “Daylighting and visual comfort of oriental sun responsive skins: A parametric analysis,” *Building Simulation*, vol. 11, pp. 663–676, 2018. <https://doi.org/10.1007/s12273-018-0433-0>
- [69] A. Tabadkani, A. Roetzel, H. X. Li, and A. Tsangrassoulis, “Design approaches and typologies of adaptive facades: A review,” *Automation in Construction*, vol. 121, p. 103450, 2021. <https://doi.org/10.1016/j.autcon.2020.103450>
- [70] S. Stevens, “Intelligent facades: Occupant control and satisfaction,” *International Journal of Solar Energy*, vol. 21, no. 2–3, pp. 147–160, 2001. <https://doi.org/10.1080/01425910108914369>
- [71] D. Saelens, J. Carmeliet, and H. Hens, “Evaluating the thermal performance of active envelopes,” in *6th Nordic Symposium on Building Physics (NSB 2002), June 17-19, 2002, Trondheim, Norway*. Norwegian Building Research Institute; SINTEF, 2002, pp. 341–348.
- [72] —, “Energy performance assessment of multiple-skin facades,” *HVAC&R Research*, vol. 9, no. 2, pp. 167–185, 2003.
- [73] A. Pierleoni, V. Serra, L. Bianco, A. Kindinis *et al.*, “Innovative technologies for transparent building envelopes: experimental assessment of energy and thermal comfort data to facilitate the decision-making process,” in *Atti convegno CIGOS 2015-Paris*. CIGOS, 2015, pp. 1–9.
- [74] L. Bakker, E. Hoes-van Oeffelen, R. Loonen, and J. L. Hensen, “User satisfaction and interaction with automated dynamic facades: A pilot study,” *Building and Environment*, vol. 78, pp. 44–52, 2014. <https://doi.org/10.1016/j.buildenv.2014.04.007>
- [75] R. Loonen, P. Hoes, and J. Hensen, “Performance prediction of buildings with responsive building elements challenges and solutions,” in *2nd IBPSA-England Conference on Building Simulation and Optimization (BSO 2014)*, 2014, pp. 1–8.
- [76] P. F. Tavares, A. R. Gaspar, A. G. Martins, and F. Frontini, “Evaluation of electrochromic windows impact in the energy performance of buildings in mediterranean climates,” *Energy Policy*, vol. 67, pp. 68–81, 2014. <https://doi.org/10.1016/j.enpol.2013.07.038>
- [77] M. de Klijn, R. Loonen, A. Zarzycka, D. de Witte, V. Sarakinioti, and J. Hensen, “Assisting the development of innovative responsive facade elements using building performance simulation,” in *Symposium on Simulation for Architecture and Urban Design, SimAUD 2017, 21-24 May 2017, Toronto, Canada*, 2017, pp. 243–250.
- [78] I. Elzeyadi, “The impacts of dynamic facade shading typologies on building energy performance and occupant’s multi-comfort,” *Architectural science Review*, vol. 60, no. 4, pp. 316–324, 2017. <https://doi.org/10.1080/00038628.2017.1337558>
- [79] H. Meng and G. Li, “A review of stimuli-responsive shape memory polymer composites,” *polymer*, vol. 54, no. 9, pp. 2199–2221, 2013. <https://doi.org/10.1016/j.polymer.2013.02.023>
- [80] C. I. Idumah, “Multifunctional properties optimization and stimuli-responsivity of shape memory polymeric nanoarchitectures and applications,” *Polymer Engineering & Science*, vol. 63, no. 7, pp. 1857–1873, 2023. <https://doi.org/10.1002/pen.26331>
- [81] Q. Chen, T. Kalpoe, and J. Jovanova, “Design of mechanically intelligent structures: Review of modeling stimuli-responsive materials for adaptive structures,” *Heliyon*, 2024. <https://doi.org/10.1016/j.heliyon.2024.e34026>
- [82] M. Gonçalves, A. Figueiredo, R. Almeida, and R. Vicente, “Dynamic facades in buildings: A systematic review across thermal comfort, energy efficiency and daylight performance,” *Renewable and Sustainable Energy Reviews*, vol. 199, p. 114474, 2024. <https://doi.org/10.1016/j.rser.2024.114474>
- [83] S. Attia, S. Bilir, T. Safy, C. Struck, R. Loonen, and F. Goia, “Current trends and future challenges in the performance assessment of adaptive facade systems,” *Energy and Buildings*, vol. 179, pp. 165–182, 2018. <https://doi.org/10.1016/j.enbuild.2018.09.017>
- [84] S. Moghtadernejad, M. S. Mirza, and L. E. Chouinard, “Facade design stages: Issues and considerations,” *Journal of Architectural Engineering*, vol. 25, no. 1, p. 04018033, 2019. [https://doi.org/10.1061/\(asce\)ae.1943-5568.0000335](https://doi.org/10.1061/(asce)ae.1943-5568.0000335)
- [85] N. Mohtashami, N. Fuchs, M. Fotopoulou, P. Drosatos, R. Streblow, T. Osterhage, and D. Müller, “State of the art of technologies in adaptive dynamic building envelopes (adbes),” *Energies*, vol. 15, no. 3, p. 829, 2022. <https://doi.org/10.3390/en15030829>
- [86] M. J. Paar and A. Petutschnigg, “Biomimetic inspired, natural ventilated facade—a conceptual study,” *Journal of Facade Design and Engineering*, vol. 4, no. 3–4, pp. 131–142, 2016. <https://doi.org/10.3233/fde-171645>
- [87] M. Arbabzadeh, I. Etessam, and M. Shemirani, “Passive thermoregulation in vernacular and biomimetic architecture in hot and arid climate,” *Int. J. Architect. Eng. Urban Plan*, vol. 30, no. 2, pp. 198–211, 2020.
- [88] L. Badarnah, “A biophysical framework of heat regulation strategies for the design of biomimetic building envelopes,”

- Procedia Engineering*, vol. 118, pp. 1225–1235, 2015. <https://doi.org/10.1016/j.proeng.2015.08.474>
- [89] D. Fecheyr-Lippens and P. Bhiwapurkar, “Applying biomimicry to design building envelopes that lower energy consumption in a hot-humid climate,” *Architectural Science Review*, vol. 60, no. 5, pp. 360–370, 2017. <https://doi.org/10.1080/00038628.2017.1359145>
- [90] A. Luible, “Memorandum of understanding for the implementation of a european concerted research action designated as cost action tu1403: Adaptive facades network,” *COST Action TU1403*, 2014.
- [91] L. Bakker, E. Hoes-van Oeffelen, R. Loonen, and J. Hensen, “User satisfaction and interaction with automated dynamic facades: A pilot study,” *Building and Environment*, vol. 78, pp. 44–52, 2014. <https://doi.org/10.1016/j.buildenv.2014.04>
- [92] N. S. Naik, I. Elzeyadi, and V. Cartwright, “Dynamic solar screens for high-performance buildings—a critical review of perforated external shading systems,” *Architectural Science Review*, vol. 65, no. 3, pp. 217–231, 2022. <https://doi.org/10.1080/00038628.2022.2063248>
- [93] N. H. Matin, A. Eydgahi, A. Gharipour, and P. Matin, “A novel framework for optimizing indoor illuminance and discovering association of involved variables,” *Buildings*, vol. 12, no. 7, p. 878, 2022. <https://doi.org/10.3390/buildings12070878>
- [94] A. Spiridonov, I. Shubin, and R. Gerashchenko, “New generation of fencing structures—dynamic/adaptive facades. prospects of the use in russia,” *Budownictwo o zoptymalizowanym potencjale energetycznym*, vol. 10, no. 1, pp. 135–144, 2021. <https://doi.org/10.17512/bozpe.2021.1.14>
- [95] C. L. Marcos, Á. J. Fernández-Álvarez *et al.*, “Spacing time. engaging temporality in the realm of architectural space.” *eCAADe*, 2015.
- [96] A. H. AbdulKarim, M. A. Tawfik, A. F. Hasan, and A. T. El-Awady, “Review of improving energy efficiency technologies,” *Journal of Environmental Science*, vol. 50, no. 8, pp. 239–286, 2021.
- [97] W. Nakapan and A. Siripattanamongkol, “Developing a kinetic facade towards a solar control facade design prototype,” in *Proceedings of the 4th RSU National and International Research Conference on Science and Technology, Social Sciences, and Humanities*, 2019.
- [98] R. C. Loonen, M. Trčka, D. Cóstola, and J. L. Hensen, “Climate adaptive building shells: State-of-the-art and future challenges,” *Renewable and sustainable energy reviews*, vol. 25, pp. 483–493, 2013. <https://doi.org/10.1016/j.rser.2013.04.016>
- [99] E. Annunziata, M. Frey, and F. Rizzi, “Towards nearly zero-energy buildings: The state-of-art of national regulations in Europe,” *Energy*, vol. 57, pp. 125–133, 2013. <https://doi.org/10.1016/j.energy.2012.11.049>
- [100] H. Bahi and M. E. H. El Azhari, “Sustainable facades for the future,” 2022.
- [101] M. C. Cimmino, R. Miranda, E. Sicignano, A. Ferreira, R. Skelton, and F. Fraternali, “Composite solar facades and wind generators with tensegrity architecture,” *Composites Part B: Engineering*, vol. 115, pp. 275–281, 2017. <https://doi.org/10.1016/j.compositesb.2016.09.077>
- [102] Y. T. A. Nasr, “Using smart materials to mimic nature in architecture,” Ph.D. dissertation, Graduate School, Faculty of Engineering, Alexandria University Alexandria, Egypt, 2017.
- [103] R. Nady, “Dynamic facades: Environmental control systems for sustainable design,” *Renewable Energy and Sustainable Development*, vol. 3, no. 1, pp. 118–127, 2017. <https://doi.org/10.21622/resd.2017.03.1.118>
- [104] J. E. Villegas, J. C. R. Gutierrez, and H. A. Colorado, “Active materials for adaptive building envelopes: A review,” *J Mater Environ Sci*, vol. 11, no. 6, pp. 988–1009, 2020.
- [105] A. Globa, G. Costin, R. Wang, C. K. Khoo, and C. Moloney, “Hybrid environmental-media facade: full-scale prototype panel fabrication,” *Architecture in the Age of the 4th Industrial Revolution—Proceedings of the 37th Education and Research in Computer Aided Design in Europe.*, pp. 685–694, 2019.
- [106] A. Globa, G. Costin, O. Tokede, R. Wang, C. K. Khoo, and J. Moloney, “Hybrid kinetic facade: fabrication and feasibility evaluation of full-scale prototypes,” *Architectural Engineering and Design Management*, vol. 18, no. 6, pp. 791–811, 2022. <https://doi.org/10.1080/17452007.2021.1941739>
- [107] J. K. Day and D. E. Gunderson, “Understanding high performance buildings: The link between occupant knowledge of passive design systems, corresponding behaviors, occupant comfort and environmental satisfaction,” *Building and Environment*, vol. 84, pp. 114–124, 2015. <https://doi.org/10.1016/j.buildenv.2014.11.003>
- [108] L. Karlsen, P. Heiselberg, and I. Bryn, “Occupant satisfaction with two blind control strategies: Slats closed and slats in cut-off position,” *Solar Energy*, vol. 115, pp. 166–179, 2015. <https://doi.org/10.1016/j.solener.2015.02.031>
- [109] S. A. Sadeghi, P. Karava, I. Konstantzos, and A. Tzempelikos, “Occupant interactions with shading and lighting systems using different control interfaces: A pilot field study,” *Building and Environment*, vol. 97, pp. 177–195, 2016. <https://doi.org/10.1016/j.buildenv.2015.12.008>
- [110] D. Borschewski, M. P. Voigt, S. Albrecht, D. Roth, M. Kreimeyer, and P. Leistner, “Why are adaptive facades not widely used in practice? Identifying ecological and economical benefits with life cycle assessment,” *Building and Environment*, vol. 232, p. 110069, 2023. <https://doi.org/10.1016/j.buildenv.2023.110069>
- [111] K. Sharaidin, “Kinetic facades: towards design for environmental performance,” Ph.D. dissertation, RMIT

- University, 2014.
- [112] M. Torres, E. Aguirre-Maldonado, F. Cuenca, and S. Ordóñez-Salazar, "Kinetic architecture as a response to adaptive behavior to climate, a case study through virtual models," *Proceedings of International Structural Engineering and Construction*, vol. 11, p. 1, 2024.
- [113] M. Brzezicki, "A systematic review of the most recent concepts in kinetic shading systems with a focus on biomimetics: A motion/deformation analysis," *Sustainability*, vol. 16, no. 13, p. 5697, 2024. <https://doi.org/10.3390/su16135697>
- [114] M. Khezri and K. Rasmussen, "Functionalising buckling for structural morphing in kinetic facades: Concepts, strategies and applications," *Thin-Walled Structures*, vol. 180, p. 109749, 2022. <https://doi.org/10.1016/j.tws.2022.109749>
- [115] J. J. Thomson, *Applications of dynamics to physics and chemistry*. Macmillan, 1888.
- [116] E. Hecht, "Relativity, potential energy, and mass," *European Journal of Physics*, vol. 37, no. 6, p. 065804, 2016. <https://doi.org/10.1088/0143-0807/37/6/065804>
- [117] W. Heisenberg, *The physical principles of the quantum theory*. Courier Corporation, 2013.
- [118] E. Taylor and R. Iyer, "Heisenberg's uncertainty principle, bohr's complementarity principle, and the copenhagen interpretation," *Physics Essays*, vol. 37, no. 1, pp. 71–73, 2024.
- [119] Y. Shao, "Analysis of principle and state-of-art implementations of heisenberg's uncertainty," *Highlights in Science, Engineering and Technology*, vol. 104, pp. 54–59, 2024. <https://doi.org/10.54097/y331d237>
- [120] Y. Xiao, Y. Yang, X. Wang, Q. Liu, and M. Gu, "Quantum uncertainty principles for measurements with interventions," *Physical Review Letters*, vol. 130, no. 24, p. 240201, 2023. <https://doi.org/10.1103/physrevlett.130.240201>
- [121] A. G. Webster, *The dynamics of particles and of rigid, elastic, and fluid bodies: being lectures on mathematical physics*. BG Teubner, 1912, vol. 11.
- [122] A. Eddington, "From euclid to eddington."
- [123] S. M. Hosseini, M. Mohammadi, and O. Guerra-Santin, "Interactive kinetic facade: Improving visual comfort based on dynamic daylight and occupant's positions by 2d and 3d shape changes," *Building and Environment*, vol. 165, p. 106396, 2019. <https://doi.org/10.1016/j.buildenv.2019.106396>
- [124] K. M. Al-Obaidi, M. A. Ismail, H. Hussein, and A. M. A. Rahman, "Biomimetic building skins: An adaptive approach," *Renewable and Sustainable Energy Reviews*, vol. 79, pp. 1472–1491, 2017. <https://doi.org/10.1016/j.rser.2017.05.028>
- [125] S. M. Hosseini, M. Mohammadi, A. Rosemann, T. Schröder, and J. Lichtenberg, "A morphological approach for kinetic facade design process to improve visual and thermal comfort," *Building and environment*, vol. 153, pp. 186–204, 2019. <https://doi.org/10.1016/j.buildenv.2019.02.040>
- [126] L. Chen, Y. Zhang, Z. Chen, Y. Dong, Y. Jiang, J. Hua, Y. Liu, A. I. Osman, M. Farghali, L. Huang *et al.*, "Biomaterials technology and policies in the building sector: A review," *Environmental Chemistry Letters*, vol. 22, no. 2, pp. 715–750, 2024. <https://doi.org/10.1007/s10311-023-01689-w>
- [127] R. Loonen, "Bio-inspired adaptive building skins," *Biotechnologies and Biomimetics for Civil Engineering*, pp. 115–134, 2014.
- [128] M. López, R. Rubio, S. Martín, B. Croxford, and R. Jackson, "Active materials for adaptive architectural envelopes based on plant adaptation principles," *Journal of Facade Design and Engineering*, vol. 3, no. 1, pp. 27–38, 2015. <https://doi.org/10.3233/fde-150026>
- [129] H. S. M. Shahin, "Adaptive building envelopes of multistory buildings as an example of high performance building skins," *Alexandria Engineering Journal*, vol. 58, no. 1, pp. 345–352, 2019. <https://doi.org/10.1016/j.aej.2018.11.013>
- [130] G. Wang, J. Fang, C. Yan, D. Huang, K. Hu, and K. Zhou, "Advancements in smart building envelopes: A comprehensive review," *Energy and Buildings*, p. 114190, 2024. <https://doi.org/10.1016/j.enbuild.2024.114190>
- [131] N. Baker and K. Steemers, *Daylight design of buildings: A handbook for architects and engineers*, Routledge, 2014.
- [132] S. Schleicher, J. Lienhard, S. Poppinga, T. Speck, and J. Knippers, "A methodology for transferring principles of plant movements to elastic systems in architecture," *Computer-Aided Design*, vol. 60, pp. 105–117, 2015. <https://doi.org/10.1016/j.cad.2014.01.005>
- [133] G. Pohl, W. Nachtigall, G. Pohl, and W. Nachtigall, "Biological support and envelope structures and their counterparts in buildings," *Biomimetics for Architecture & Design: Nature-Analogies-Technology*, pp. 131–177, 2015. https://doi.org/10.1007/978-3-319-19120-1_5
- [134] G. Schieber, L. Born, P. Bergmann, A. Körner, A. Mader, S. Saffarian, O. Betz, M. Milwich, G. Gresser, and J. Knippers, "Hindwings of insects as concept generator for hingeless foldable shading systems," *Bioinspiration & biomimetics*, vol. 13, no. 1, p. 016012, 2017. <https://doi.org/10.1088/1748-3190/aa979c>
- [135] Y. Xing, P. Jones, M. Bosch, I. Donnison, M. Spear, and G. Ormondroyd, "Exploring design principles of biological and living building envelopes: what can we learn from plant cell walls?" *Intelligent Buildings International*, vol. 10, no. 2, pp. 78–102, 2018. <https://doi.org/10.1080/17508975.2017.1394808>
- [136] E. Hertzsch, "Sustainable buildings: Biomimicry and textile applications," in *Textiles, Polymers and Composites for Buildings*. Elsevier, 2010, pp. 375–397. <https://doi.org/10.1533/9780845699994.2.375>

- [137] G. Pohl, W. Nachtigall, G. Pohl, and W. Nachtigall, "Products and architecture: examples of biomimetics for buildings," *Biomimetics for Architecture & Design: Nature-Analogies-Technology*, pp. 179–312, 2015.
- [138] B. Svetozarevic, M. Begle, P. Jayathissa, S. Caranovic, R. F. Shepherd, Z. Nagy, I. Hirschier, J. Hofer, and A. Schlueter, "Dynamic photovoltaic building envelopes for adaptive energy and comfort management," *Nature Energy*, vol. 4, no. 8, pp. 671–682, 2019. <https://doi.org/10.1038/s41560-019-0424-0>
- [139] L. Badarnah, "Form follows environment: Biomimetic approaches to building envelope design for environmental adaptation," *Buildings*, vol. 7, no. 2, p. 40, 2017. <https://doi.org/10.3390/buildings7020040>
- [140] A. N. El Houda and D. Mohamed, "Advanced building skins inspired from plants adaptation strategies to environmental stimuli: A review," in *2018 International Conference on Applied Smart Systems (ICASS)*. IEEE, 2018, pp. 1–7.
- [141] S. M. Hosseini, F. Fadli, and M. Mohammadi, "Biomimetic kinetic shading facade inspired by tree morphology for improving occupant's daylight performance," 2021.
- [142] S. M. Hosseini, M. Mohammadi, T. Schröder, and O. Guerra-Santin, "Bio-inspired interactive kinetic facade: Using dynamic transitory-sensitive area to improve multiple occupants' visual comfort," *Frontiers of Architectural Research*, vol. 10, no. 4, pp. 821–837, 2021. <https://doi.org/10.1016/j.foar.2021.07.004>
- [143] R. N. Faragllah, "Biomimetic approaches for adaptive building envelopes: Applications and design considerations," *Civil Engineering and Architecture*, vol. 9, pp. 2464–2475, 2021. <https://doi.org/10.13189/cea.2021.090731>
- [144] Y. Akgün, Ö. E. Erkarlsan, and C. Kavuncuoğlu, "Tectonics of kinetic architecture: Moving envelope, changing space and the shades of the shed," *Frontiers in Built Environment*, vol. 8, p. 1006300, 2022. <https://doi.org/10.3389/fbuil.2022.1006300>
- [145] R. Kronenburg, "Flexible: Architecture that responds to change," *Laurance King*, 2007.
- [146] P. Holland, "Quantum potential energy as concealed motion," *Foundations of Physics*, vol. 45, pp. 134–141, 2015. <https://doi.org/10.1007/s10701-014-9852-7>
- [147] T. Han, J. D. Lykken, and R.-J. Zhang, "Kaluza-klein states from large extra dimensions," *Physical Review D*, vol. 59, no. 10, p. 105006, 1999. <https://doi.org/10.1103/physrevd.59.105006>
- [148] R. Velasco, A. P. Brakke, and D. Chavarro, "Dynamic facades and computation: Towards an inclusive categorization of high performance kinetic facade systems," in *Computer-Aided Architectural Design Futures. The Next City-New Technologies and the Future of the Built Environment: 16th International Conference, CAAD Futures 2015, São Paulo, Brazil, July 8–10, 2015. Selected Papers 16*. Springer, 2015, pp. 172–191.
- [149] M. López, R. Rubio, S. Martín, and B. Croxford, "How plants inspire facades. from plants to architecture: Biomimetic principles for the development of adaptive architectural envelopes," *Renewable and Sustainable Energy Reviews*, vol. 67, pp. 692–703, 2017. <https://doi.org/10.1016/j.rser.2016.09.018>
- [150] S. Habibi, O. P. Valladares, and D. M. Peña, "Sustainability performance by ten representative intelligent facade technologies: A systematic review," *Sustainable Energy Technologies and Assessments*, vol. 52, p. 102001, 2022. <https://doi.org/10.1016/j.seta.2022.102001>
- [151] J. Knippers, F. Scheible, M. Oppe, and H. Jungjohann, "Bio-inspired kinetic gfrp-facade for the thematic pavilion of the expo 2012 in yeosu," in *International Symposium of Shell and Spatial Structures (IASS 2012)*, vol. 90, no. 6, 2012, pp. 341–347.
- [152] I. J. Kadhim and A. Na'im Mohsin, "Antivirus architecture: Links between epidemic thought and images," in *IOP Conference Series: Materials Science and Engineering*, vol. 1067, no. 1. IOP Publishing, 2021, p. 012027. <https://doi.org/10.1088/1757-899x/1067/1/012027>
- [153] A. Taghaboni, "Sharifi-ha house," in *New MOVE*. Birkhäuser, 2019, pp. 110–111.
- [154] Archdaily. Sharifi Ha House Nextoffice. [Online]. Available: <https://www.archdaily.com/522344/sharifi-ha-house-nextoffice/53bbe6bdc07a8005ce00037a-sharifi-ha-house-nextoffice-diagram-04?next,roject=no>
- [155] Newatlas. Passively-cooled Portuguese home doesn't break the bank. Available: <https://newatlas.com/e348-arquitectura-miramar-house/32047/>.
- [156] F. Mehrvarz, M. Bemanian, T. Nasr, R. Mansoori, M. F. AL-Kazee, W. A. Khudhayer, and M. Mahdaveinejad, "Designerly approach to design responsive facade for occupant visual comfort in different latitudes," *Journal of Daylighting*, vol. 11, no. 1, pp. 149–164, 2024. <https://doi.org/10.15627/jd.2024.9>
- [157] A. Premier, "Dynamic facades and smart technologies for building envelope requalification," *Screencity-International Academic Journal*, vol. 1, pp. 65–69, 2012.
- [158] Z. Nagy, B. Svetozarevic, P. Jayathissa, M. Begle, J. Hofer, G. Lydon, A. Willmann, and A. Schlueter, "The adaptive solar facade: From concept to proto-type," *Frontiers of Architectural Research*, vol. 5, no. 2, pp. 143–156, 2016. <https://doi.org/10.1016/j.foar.2016.03.002>
- [159] P. Jayathissa, J. Schmidli, J. Hofer, and A. Schlueter, "Energy performance of pv modules as adaptive building shading systems," *EUPVSEC*, pp. 2513–2517, 2016.
- [160] moritz. Adaptive Solar Facade. [Online]. Available: <http://www.moritz-begle.com/asf-adaptive-solar-facade.html>
- [161] J. A. Ibrahim and H. Z. Alibaba, "Kinetic facade as a tool for energy efficiency," *International Journal of Engineering Research and Reviews*, vol. 7, pp. 1–7, 2019.

- [162] F. Salah and M. T. Kayili, "Responsive kinetic facade strategy and determination of the effect on solar heat gain using parametric bim-based energy simulation," *Journal of Green Building*, vol. 17, no. 1, pp. 71–88, 2022. <https://doi.org/10.3992/jgb.17.1.71>
- [163] M. H. H. Zamri, N. A. Sukindar, F. M. Nor, M. A. A. H. Ismail, L. B. Lei, and A. A. Ab Aziz, "Dynamic folding envelope design," *Semarak International Journal of Creative Art and Design*, vol. 1, no. 1, pp. 14–23, 2024.
- [164] S. M. Hosseini, S. Heidari, S. Attia, J. Wang, and G. Triantafyllidis, "Biomimetic kinetic facade as a real-time daylight control: complex form versus simple form with proper kinetic behavior," *Smart and Sustainable Built Environment*, 2024. <https://doi.org/10.1108/sasbe-03-2024-0090>
- [165] N. Nasrullah and S. Syafri, "Innovative sustainable design approaches in urban architecture: Balancing aesthetics and environmental impact," *Global International Journal of Innovative Research*, vol. 2, no. 9, 2024. <https://doi.org/10.59613/global.v2i9.290>
- [166] W. Baker, C. Besjak, B. McElhatten, and X. Li, "Pearl River tower: Design integration towards sustainability," in *Structures Congress 2014*, 2014, pp. 747–757.
- [167] K. Dewidar, A. H. Mahmoud, N. Magdy, and S. Ahmed, "The role of intelligent facades in energy conservation," in *International Conference on Sustainability and the Future: Future Intermediate Sustainable Cities (FISC 2010)*, vol. 1, 2010.
- [168] Guangzhou, Guangdong . Pearl River Tower Skidmore, Owings & Merrill LLP. [Online]. Available: <https://ongreening.com/en/Projects/pearl-river-tower-1206>
- [169] I. Abdelsabour, "Performative architecture: Facades' pattern effect on architectural performance," *Journal of Engineering and Applied Science*, vol. 64, no. 3, pp. 165–187, 2017.
- [170] Ribaj. Campus Kolding University of Southern Denmark. [Online]. Available: <https://www.ribaj.com/products/campus-kolding-university-of-southern-denmark>
- [171] M. Mohamed and L. Bande, "Parametric study and comparative efficiency of islamic geometric patterns as a retrofit strategy in mid-rise buildings of al ain city, abu dhabi, uae," *Sustain. Dev. Plan. XII*, vol. 258, pp. 317–327, 2022. <https://doi.org/10.2495/sdp220271>
- [172] S. Attia, "Evaluation of adaptive facades: The case study of al bahr towers in the uae," *QScience Connect*, vol. 2017, no. 2, p. 6, 2017. <https://doi.org/10.5339/connect.2017.qgbc.6>
- [173] A. Rocca, "Experiments and utopias of a sustainable architecture," *Territorio*, 103, 4, 2022, pp. 84–88, 2022. <https://doi.org/10.3280/tr2023-103015>
- [174] Z. Mi, "Sustainable architectural practices: Integrating green design, smart technologies, and ultra-low energy concepts," *Theoretical and Natural Science*, vol. 40, pp. 8–13, 2024. <https://doi.org/10.54254/2753-8818/48/20240203>
- [175] K. A. Benaïda, "Force-driven weave patterns for shell structures in architectural design," 2018.
- [176] R. K. Goyal, "Exploring quantum materials & applications: A review," *arXiv preprint arXiv:2404.17594*, 2024.
- [177] M. Casini, *Smart buildings: Advanced materials and nanotechnology to improve energy-efficiency and environmental performance*. Woodhead Publishing, 2016.
- [178] —, "Active dynamic windows for buildings: A review," *Renewable Energy*, vol. 119, pp. 923–934, 2018. <https://doi.org/10.1016/j.renene.2017.12.049>
- [179] F. Sommese, L. Badarnah, and G. Ausiello, "Smart materials for biomimetic building envelopes: current trends and potential applications," *Renewable and Sustainable Energy Reviews*, vol. 188, p. 113847, 2023. <https://doi.org/10.1016/j.rser.2023.113847>
- [180] M. Ahmadizadeh, M. Heidari, S. Thangavel, M. Khashehchi, P. Rahmanivahid, V. P. Singh, and A. Kumar, "Development of new materials for sustainable buildings," in *Sustainable Technologies for Energy Efficient Buildings*. CRC Press, 2024, pp. 30–48.
- [181] D. B. Tripathy and A. Gupta, "Nanocomposites as sustainable smart materials: A review," *Journal of Reinforced Plastics and Composites*, p. 07316844241233162, 2024. <https://doi.org/10.1177/07316844241233162>
- [182] M. H. M. Fahmy, "Nanomaterials and architecture sustainable nano architecture," *Master of Science Degree Thesis, University of Alexandria, Graduate School of Engineering*, 2010.
- [183] D. Basov, R. Averitt, and D. Hsieh, "Towards properties on demand in quantum materials," *Nature Materials*, vol. 16, no. 11, pp. 1077–1088, 2017. <https://doi.org/10.1038/nmat5017>
- [184] G. Górski, K. Wójcik, J. Barański, I. Weymann, and T. Domański, "Nonlocal correlations transmitted between quantum dots via short topological superconductor," *Scientific Reports*, vol. 14, no. 1, p. 13848, 2024. <https://doi.org/10.1038/s41598-024-64578-4>
- [185] R. W. Fleming, F. Jäkel, and L. T. Maloney, "Visual perception of thick transparent materials," *Psychological science*, vol. 22, no. 6, pp. 812–820, 2011. <https://doi.org/10.1177/0956797611408734>
- [186] P. Wang, Z. Liu, L. Zhang, C. Zhao, X. Jiang, and B. Li, "Adaptive building envelope combining variable transparency shape-stabilized pcm and reflective film: Parameter and energy performance optimization in different climate conditions," *Energy Conversion and Management*, vol. 299, p. 117907, 2024. <https://doi.org/10.1016/j.enconman.2023.117907>
- [187] A. R. AbouElhamd, K. A. Al-Sallal, and A. Hassan, "Review of core/shell quantum dots technology integrated into

- building's glazing," *Energies*, vol. 12, no. 6, p. 1058, 2019. <https://doi.org/10.3390/en12061058>
- [188] Z. Li, H. Wu, and R. Wang, "Actuality and technology prospect of using per-ovskite quantum dot solar cells as the photovoltaic roof," *Solar Energy*, vol. 269, pp. 112359, 2024. <https://doi.org/10.1016/j.solener.2024.112359>
- [189] H. Rezazadeh, Z. Salahshoor, F. Ahmadi, and F. Nasrollahi, "Reduction of carbon dioxide by bio-facades for sustainable development of the environment," *Environmental engineering research*, vol. 27, no. 2, 2022. <https://doi.org/10.4491/eer.2020.583>
- [190] F. Meinardi, F. Bruni, C. Castellan, M. Meucci, A. M. Umair, M. La Rosa, J. Catani, and S. Brovelli, "Certification grade quantum dot luminescent solar concentrator glazing with optical wireless communication capability for connected sustainable architecture," *Advanced Energy Materials*, vol. 14, no. 16, p. 2304006, 2024. <https://doi.org/10.1002/aenm.202304006>
- [191] X. Liu and Y. Wu, "A review of advanced architectural glazing technologies for solar energy conversion and intelligent daylighting control," *Architectural Intelligence*, vol. 1, no. 1, p. 10, 2022. <https://doi.org/10.1007/s44223-022-00009-6>
- [192] E. Attia, R. Diab, and A. Fekry Mostafa, "Integration of photovoltaic cells with the architectural design of sustainable public buildings," *Journal of Engineering Research*, vol. 7, no. 4, pp. 174–182, 2023. <https://doi.org/10.21608/erjeng.2023.331936>
- [193] M. P. Gutierrez and L. P. Lee, "Multiscale design and integration of sustainable building functions," *Science*, vol. 341, no. 6143, pp. 247–248, 2013. <https://doi.org/10.1126/science.1237278>
- [194] Y. O. Elkhatat, "Interactive movement in kinetic architecture," *JES. Journal of Engineering Sciences*, vol. 42, no. 3, pp. 816–845, 2014. <https://doi.org/10.21608/jesaun.2014.115027>
- [195] N. Heidari Matin and A. Eydgahi, "Technologies used in responsive facade systems: a comparative study," *Intelligent buildings international*, vol. 14, no. 1, pp. 54–73, 2022. <https://doi.org/10.1080/17508975.2019.1577213>
- [196] T. D. Nguyen, L. P. Yeo, A. J. Ong, W. Zhiwei, D. Mandler, S. Magdassi, and A. I. Y. Tok, "Electrochromic smart glass coating on functional nano-frameworks for effective building energy conservation," *Materials Today Energy*, vol. 18, p. 100496, 2020. <https://doi.org/10.1016/j.mtener.2020.100496>
- [197] O. Gamayunova, E. Gumerova, and N. Miloradova, "Smart glass as the method of improving the energy efficiency of high-rise buildings," in *E3S Web of Conferences*, vol. 33. EDP Sciences, 2018, p. 02046.
- [198] Y. Deng, Y. Yang, Y. Xiao, X. Zeng, H.-L. Xie, R. Lan, L. Zhang, and H. Yang, "Annual energy-saving smart windows with actively controllable passive radiative cooling and multimode heating regulation," *Advanced Materials*, pp. 2401869, 2024. <https://doi.org/10.1002/adma.202401869>
- [199] C. Ma, Z. Zhang, Y. Yang, P. Wang, M. Yu, Y. Gao, Q. Wang, J. Xiao, C. Zou, and H. Yang, "A smart window with passive radiative cooling and switchable near-infrared light transmittance via molecular engineering," *ACS Applied Materials & Interfaces*, vol. 16, no. 19, pp. 25343–25352, 2024. <https://doi.org/10.1021/acsami.4c02819>
- [200] Y. Ming, Y. Sun, X. Liu, X. Liu, and Y. Wu, "Thermal performance of an advanced smart fenestration systems for low-energy buildings," *Applied Thermal Engineering*, vol. 244, p. 122610, 2024. <https://doi.org/10.1016/j.applthermaleng.2024.122610>
- [201] J. Hu and S. Liu, "Engineering responsive polymer building blocks with host-guest molecular recognition for functional applications," *Accounts of Chemical Research*, vol. 47, no. 7, pp. 2084–2095, 2014. <https://doi.org/10.1021/ar5001007>
- [202] Y. Luo, L. Zhang, M. Bozlar, Z. Liu, H. Guo, and F. Meggers, "Active building envelope systems toward renewable and sustainable energy," *Renewable and Sustainable Energy Reviews*, vol. 104, pp. 470–491, 2019. <https://doi.org/10.1016/j.rser.2019.01.005>
- [203] H. Zhan, N. Mahyuddin, R. Sulaiman, and F. Khayatian, "Phase change material (pcm) integrations into buildings in hot climates with simulation access for energy performance and thermal comfort: A review," *Construction and Building Materials*, vol. 397, p. 132312, 2023. <https://doi.org/10.1016/j.conbuildmat.2023.132312>
- [204] X. Zhu, J. Liu, K. Yang, L. Zhang, S. Wang, and X. Liu, "Structurally engineered 3d porous graphene based phase change composite with highly efficient multi-energy conversion and versatile applications," *Composites Part B: Engineering*, vol. 272, p. 111233, 2024. <https://doi.org/10.1016/j.compositesb.2024.111233>
- [205] J. Shuang, M. Qin, M. Jia, Z. Shen, Y. Wang, and R. Zou, "Colossal barocaloric effect in encapsulated solid-liquid phase change materials," *Advanced Functional Materials*, p. 2413924, 2024. <https://doi.org/10.1002/adfm.202413924>
- [206] M. Zhi, S. Yue, L. Zheng, B. Su, J. Fu, and Q. Sun, "Recent developments in solid-solid phase change materials for thermal energy storage applications," *Journal of Energy Storage*, vol. 89, p. 111570, 2024. <https://doi.org/10.1016/j.est.2024.111570>
- [207] S. Polverino, "Graphene-based construction materials: Experimentation and application development," 2021.
- [208] H. Mamdouh, "Using nanotechnology in construction materials to raise energy efficiency as an approach to sustainability," 2023.
- [209] M. Zameem, P. Beccarelli, and C. Wood, "Adaptive facade using smp actuator for enhancing thermal performance in buildings," 2023.
- [210] G. Guldentops, G. Ardito, M. Tao, S. Granados-Focil, and S. Van Dessel, "A numerical study of adaptive building

- enclosure systems using solid–solid phase change materials with variable transparency,” *Energy and Buildings*, vol. 167, pp. 240–252, 2018. <https://doi.org/10.1016/j.enbuild.2018.02.054>
- [211] D. Lee, M. F. Rubner, and R. E. Cohen, “All-nanoparticle thin-film coatings,” *Nano Letters*, vol. 6, no. 10, pp. 2305–2312, 2006.
- [212] F. Flory, L. Escoubas, and G. Berginc, “Optical properties of nanostructured materials: A review,” *Journal of Nanophotonics*, vol. 5, no. 1, pp. 052502–052502, 2011.
- [213] S. Kumar, N. Verma, and M. Singla, “Size dependent reflective properties of tio2 nanoparticles and reflectors made thereof,” *Digest Journal of Nanomaterials and Biostructures*, vol. 7, no. 2, pp. 607–619, 2012.
- [214] J. P. Mendes, P. S. dos Santos, B. Dias, S. Núñez-Sánchez, I. Pastoriza-Santos, J. P´erez-Juste, C. M. Pereira, P. A. Jorge, J. M. de Almeida, and L. C. Coelho, “Exciting surface plasmon resonances on gold thin film-coated optical fibers through nanoparticle light scattering,” *Advanced Optical Materials*, vol. 12, no. 25, p. 2400433, 2024. <https://doi.org/10.1002/adom.202400433>
- [215] D. Berenstein and G. Hulsey, “One-dimensional reflection in the quantum me- chanical bootstrap,” *Physical Review D*, vol. 109, no. 2, p. 025013, 2024. <https://doi.org/10.1103/physrevd.109.025013>
- [216] A. Battal *et al.*, “The use of smart materials in architecture: Nitinol-based foldable fa,cade systems,” *Journal of Technology in Architecture, Design and Planning*, vol. 1, no. 1, pp. 1–9, 2023. <https://doi.org/10.26650/jtadp.01.001>
- [217] F. Sommese, “Adaptive building envelope,” in *Re-thinking the Building Enve- lope: Lessons from Nature in the Era of Climate Change*. Springer, 2024, pp. 11–38.
- [218] L. Rudzite, I. Vam`za, and R. Vanaga, “Adaptive building envelope structures,” in *CONNECT. International Scientific Conference of Environmental and Climate Technologies*, 2024, pp. 35–35.
- [219] N. Hays, L. Badarnah, and A. Jain, “Biomimetic design of building facades: an evolutionary-based computational approach inspired by elephant skin for cooling in hot and humid climates,” *Frontiers in Built Environment*, vol. 10, pp. 1309621, 2024. <https://doi.org/10.3389/fbuil.2024.1309621>
- [220] J. Vijayalaxmi, “Applications of smart building materials in sustainable archi- tecture,” in *Building Thermal Performance and Sustainability*. Springer, 2023, pp. 165–176.
- [221] P. Mishra and G. Singh, “Energy management systems in sustainable smart cities based on the internet of energy: A technical review,” *Energies*, vol. 16, no. 19, pp. 6903, 2023. <https://doi.org/10.3390/en16196903>
- [222] A. A. Firoozi and A. A. Firoozi, “Smart facades in architecture: Driving energy efficiency and adaptive urban design,” *Available at SSRN 4631796*, 2023. <https://doi.org/10.2139/ssrn.4631796>
- [223] M. Vasiliev, M. Nur-E.-Alam, and K. Alameh, “Recent developments in solar energy-harvesting technologies for building integration and distributed energy generation,” *Energies*, vol. 12, no. 6, p. 1080, 2019. <https://doi.org/10.20944/preprints201902.0165.v1>
- [224] Y. Ke, J. Chen, G. Lin, S. Wang, Y. Zhou, J. Yin, P. S. Lee, and Y. Long, “Smart windows: electro-, thermo-, mechano-, photochromics, and beyond,” *Advanced Energy Materials*, vol. 9, no. 39, pp. 1902066, 2019. <https://doi.org/10.1002/aenm.2019070153>
- [225] R. Tällberg, B. P. Jelle, R. Loonen, T. Gao, and M. Hamdy, “Comparison of the energy saving potential of adaptive and controllable smart windows: A state- of-the-art review and simulation studies of thermochromic, photochromic and electrochromic technologies,” *Solar Energy Materials and Solar Cells*, vol. 200, pp. 109828, 2019. <https://doi.org/10.1016/j.solmat.2019.02.041>
- [226] M. M. Hossain and M. Gu, “Radiative cooling: principles, progress, and poten- tials,” *Advanced Science*, vol. 3, no. 7, p. 1500360, 2016. <https://doi.org/10.1002/advs.201500360>
- [227] X. Yin, R. Yang, G. Tan, and S. Fan, “Terrestrial radiative cooling: Using the cold universe as a renewable and sustainable energy source,” *Science*, vol. 370, no. 6518, pp. 786–791, 2020. <https://doi.org/10.1126/science.abb0971>
- [228] F. Sommese, S. M. Hosseini, L. Badarnah, F. Capozzi, S. Giordano, V. Ambrogì, and G. Ausiello, “Light-responsive kinetic fa,cade system inspired by the gazania flower: A biomimetic approach in parametric design for daylighting,” *Building and Environment*, vol. 247, pp. 111052, 2024. <https://doi.org/10.1016/j.buildenv.2023.111052>
- [229] J. Kuszniar and P. Kuszniar, “Application possibilities of using smart glass materials for shading sunlight control,” in *2023 Progress in Applied Electrical Engineering (PAEE)*. IEEE, 2023, pp. 1–5.
- [230] R. Kay, C. Katrycz, K. Niti`ema, J. A. Jakubiec, and B. D. Hatton, “Decapod- inspired pigment modulation for active building facades,” *Nature Communica- tions*, vol. 13, no. 1, p. 4120, 2022. <https://doi.org/10.1038/s41467-022-31527-6>
- [231] R. Kalyanam and S. Hoffmann, “A reinforcement learning-based approach to automate the electrochromic glass and to enhance the visual comfort,” *Applied sciences*, vol. 11, no. 15, p. 6949, 2021. <https://doi.org/10.3390/app11156949>
- [232] A. A. Umoh, A. Adefemi, K. I. Ibewe, E. A. Etukudoh, V. I. Ilojiana, and Z. Q. S. Nwokediegwu, “Green architecture and energy efficiency: a review of innovative design and construction techniques,” *Engineering Science & Tech- nology Journal*, vol. 5, no. 1, pp. 185–200, 2024. <https://doi.org/10.51594/estj.v5i1.743>
- [233] O. U. Onwuka and A. Adu, “Technological synergies for sustainable resource discovery: Enhancing energy exploration with carbon management,” *Engineer- ing Science & Technology Journal*, vol. 5, no. 4, pp. 1203–1213, 2024. <https://doi.org/10.51594/estj.v5i4.996>
- [234] D. Rossi, Z. Nagy, and A. Schlueter, “Adaptive distributed robotics for envi- ronmental performance, occupant comfort

- and architectural expression,” *International Journal of Architectural Computing*, vol. 10, no. 3, pp. 341–359, 2012. <https://doi.org/10.1260/1478-0771.10.3.341>
- [235] Z. Nagy, D. Rossi, and A. Schlueter, “Sustainable architecture and human comfort through adaptive distributed systems,” in *2012 IEEE International Conference on Pervasive Computing and Communications Workshops*. IEEE, 2012, pp. 403–406.
- [236] F. Goia, L. Bianco, Y. Cascone, M. Perino, and V. Serra, “Experimental analysis of an advanced dynamic glazing prototype integrating pcm and thermotropic layers,” *Energy Procedia*, vol. 48, pp. 1272–1281, 2014. <https://doi.org/10.1016/j.egypro.2014.02.144>
- [237] S. Habibi, O. P. Valladares, and D. Pena, “New sustainability assessment model for intelligent facade layers when applied to refurbish school buildings skins,” *Sustainable Energy Technologies and Assessments*, vol. 42, p. 100839, 2020. <https://doi.org/10.1016/j.seta.2020.100839>
- [238] Q. Al-Yasiri and M. Szabó, “Numerical analysis of thin building envelope-integrated phase change material towards energy-efficient buildings in severe hot location,” *Sustainable Cities and Society*, vol. 89, p. 104365, 2023. <https://doi.org/10.1016/j.scs.2022.104365>
- [239] N. Agusniansyah, “Integration of modern facade design with traditional bubungan tinggi facade: Towards a sustainable smart home,” *ASEAN Journal on Science and Technology for Development*, vol. 41, no. 3, pp. 6, 2024. <https://doi.org/10.20944/preprints202407.1436.v1>
- [240] M. Heidari, S. Thangavel, E. Al Naamani, and M. Khashehchi, “Emerging trends in smart green building technologies,” *Sustainable Technologies for Energy Efficient Buildings*, p. 313, 2024. <https://doi.org/10.1201/9781003496656-15>
- [241] N. U. Huda, I. Ahmed, M. Adnan, M. Ali, and F. Naeem, “Experts and intelligent systems for smart homes’ transformation to sustainable smart cities: A comprehensive review,” *Expert Systems with Applications*, vol. 238, p. 122380, 2024. <https://doi.org/10.1016/j.eswa.2023.122380>
- [242] A. F. Almaz, E. A. E.-a. El-Agouz, M. T. Abdelfatah, and I. R. Mohamed, “The future role of artificial intelligence (ai) design’s integration into architectural and interior design education is to improve efficiency, sustainability, and creativity,” *Sustainability, and Creativity*, vol. 3, no. 12, pp. 1749–1772, 2024. <https://doi.org/10.13189/cea.2024.120336>
- [243] F. Saleh, A. Elhendawi, A. S. Darwish, P. Farrell *et al.*, “A framework for leveraging the incorporation of ai, bim, and iot to achieve smart sustainable cities,” *Journal of Intelligent Systems and Internet of Things*, vol. 11, no. 2, pp. 75–84, 2024.
- [244] A. A. Umoh, C. N. Nwasike, O. A. Tula, O. O. Adekoya, and J. O. Gidiagba, “A review of smart green building technologies: Investigating the integration and impact of ai and iot in sustainable building designs,” *Computer Science & IT Research Journal*, vol. 5, no. 1, pp. 141–165, 2024. <https://doi.org/10.51594/csitrj.v5i1.715>
- [245] D. Salamaga, D. A. Guerra-Zubiaga, and R. C. Voicu, “Intelligent facade innovation (ifi): Using iiot, digital twin, and next-gen architecture designs,” in *ASME International Mechanical Engineering Congress and Exposition*, vol. 87608. American Society of Mechanical Engineers, 2023, p. V003T03A0. <https://doi.org/10.1115/imece2023-113117>